

INSTALLATION MANUAL AIR CONDITIONER

- Please read this installation manual completely before installing the product.
- Installation work must be performed in accordance with the national wiring standards by authorized personnel only.
- Please retain this installation manual for future reference after reading it thoroughly.

TYPE : Air-to-Water Heat Pump

THERMAV™

TABLE OF CONTENTS

ITEMS INSIDE PRODUCT BOX	5
INDOOR UNIT BOX.....	5
OUTDOOR UNIT BOX.....	5
PREFACE.....	6
1. SAFETY PRECAUTION.....	7
WARNING.....	7
INSTALLATION WARNING.....	7
OPERATION WARNING.....	8
CAUTION.....	9
INSTALLATION CAUTION.....	9
OPERATION CAUTION.....	9
2. GENERAL INFORMATION.....	10
MODEL INFORMATION.....	11
ACCESSORIES.....	12
ACCESSORIES SUPPORTED BY LG Electronics.....	12
ACCESSORIES SUPPORTED BY 3rd PARTY COMPANIES.....	12
TYPICAL INSTALLATION EXAMPLE.....	13
CASE 1.....	13
CASE 2.....	14
CASE 3.....	15
CYCLE DIAGRAM.....	16
REFRIGERANT CYCLE.....	16
WATER CYCLE.....	18
PARTS AND DIMENSIONS.....	19
INDOOR UNIT (EXTERNAL).....	19
INDOOR UNIT (INTERNAL).....	21
OUTDOOR UNIT (EXTERNAL).....	21
CONTROL PARTS.....	24
CONTROL BOX : INDOOR UNIT.....	24
CONTROL PANEL.....	25
WIRING DIAGRAM : INDOOR UNIT.....	25
CIRCUIT DIAGRAM : INDOOR UNIT.....	25
WIRING DIAGRAM : OUTDOOR UNIT.....	25
WIRING DIAGRAM : INDOOR UNIT AND OUTDOOR UNIT (INCL. FIELD WIRING).....	26





3. INSTALLATION OF OUTDOOR UNIT	30
CONDITIONS WHERE OUTDOOR UNIT IS INSTALLED	30
DRILL A HOLE IN THE WALL	30
INSTALLATION AT SEASIDE	31
SEASONAL WIND AND CAUTIONS IN WINTER	31
4. INSTALLATION OF INDOOR UNIT	32
CONDITIONS WHERE INDOOR UNIT IS INSTALLED	32
GENERAL CONSIDERATIONS	32
SERVICE SPACE	32
MOUNTING TO WALL	33
WATER VOLUME AND WATER PUMP CAPACITY	34
WATER VOLUME AND EXPANSION VESSEL PRESSURE	35
WATER QUALITY	36
CONDITIONS IF ACCESSORIES ARE INSTALLED	37
THERMOSTAT	37
REMOTE AIR TEMPERATURE SENSOR	37
SANITARY WATER TANK AND SANITARY WATER TANK KIT / SOLAR THERMAL KIT ...	38
3WAY VALVE(2WAY VALVE)	40
5. PIPING AND WIRING FOR OUTDOOR UNIT	41
REFRIGERANT PIPING	41
CONSTRAINTS IN PIPE LENGTH AND ELEVATION	41
PREPARATION FOR PIPING	42
CONNECTING PIPE TO INDOOR UNIT	43
CONNECTING PIPE TO OUTDOOR UNIT	43
ELECTRICAL WIRING	46
WIRE SPECIFICATION	46
CIRCUIT BREAKER SPECIFICATION	47
WIRING PROCEDURE FOR POWER CABLE AND CONNECTING CABLE	47
FINALIZING	49
PIPE FORMING	49
LEAKAGE TEST AND EVACUATION	50
PREPARATION	50
LEAKAGE TEST	50
EVACUATION	51
6. PIPING AND WIRING FOR INDOOR UNIT	52
WATER PIPING AND WATER CIRCUIT CONNECTION	52
GENERAL CONSIDERATIONS	52
WATER PIPING AND WATER CIRCUIT CONNECTION	52
WATER CHARGING	54
PIPE INSULATION	54

ELECTRICAL WIRING.....	55
<i>GENERAL CONSIDERATION.....</i>	<i>55</i>
<i>TERMINAL BLOCK INFORMATION</i>	<i>56</i>
<i>CONNECTING WITH OUTDOOR UNIT</i>	<i>58</i>
<i>ELECTRIC HEATER WIRING.....</i>	<i>58</i>
7. ACCESSORIES INSTALLATION.....	59
BEFORE INSTALLATION	59
THERMOSTAT	59
<i>GENERAL INFORMATION</i>	<i>59</i>
<i>HOW TO WIRE THERMOSTAT</i>	<i>60</i>
<i>FINAL CHECK.....</i>	<i>61</i>
SANITARY WATER TANK AND SANITARY WATER TANK KIT/SOLAR THERMAL KIT	62
<i>GENERAL INFORMATION</i>	<i>62</i>
<i>HOW TO INSTALL SANITARY WATER TANK.....</i>	<i>63</i>
<i>HOW TO INSTALL SANITARY WATER TANK KIT</i>	<i>64</i>
<i>HOW TO WIRE SANITARY WATER TANK HEATER.....</i>	<i>66</i>
<i>HOW TO INSTALL SOLAR THERMAL KIT.....</i>	<i>67</i>
DRY CONTACT.....	67
REMOTE TEMPERATURE SENSOR.....	67
3WAY VALVE	68
<i>HOW TO WIRE 3WAY VALVE</i>	<i>68</i>
<i>FINAL CHECK.....</i>	<i>68</i>
2WAY VALVE	69
<i>GENERAL INFORMATION</i>	<i>69</i>
<i>HOW TO WIRE 2WAY VALVE</i>	<i>69</i>
<i>FINAL CHECK.....</i>	<i>69</i>
8. SYSTEM SET-UP	70
DIP SWITCH SETTING.....	70
<i>GENERAL INFORMATION</i>	<i>70</i>
<i>DIP SWITCH INFORMATION.....</i>	<i>71</i>
CONTROL PANEL SETTING.....	74
<i>HOW TO ENTER INSTALLER SETTING MODE.....</i>	<i>74</i>
<i>SUMMARY</i>	<i>76</i>
<i>COMMON SETTING</i>	<i>81</i>
<i>TEMPERATURE RANGE SETTING</i>	<i>82</i>
<i>TEMPERATURE CONTROL PARAMETER SETTING AND ETC.....</i>	<i>83</i>
9. CHECK POINTS, MAINTENANCE AND TROUBLESHOOTING.....	88
CHECK LIST BEFORE STARTING OPERATION.....	88
MAINTENANCE	89
TROUBLESHOOTING	90
<i>TROUBLESHOOTING FOR PROBLEM WHILE OPERATION.....</i>	<i>90</i>

Items Inside Product Box

Thank you for choosing LG Electronics Air-to-Water Heat Pump **THERMAV**.

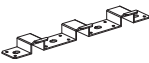
Before starting installation, please make it sure that all parts are found inside the product box.

INDOOR UNIT BOX					
Item	Image	Quantity	Item	Image	Quantity
Indoor unit		1	Shut-off valve		2
Installation Manual		1	Installation plate		1
Owner's Manual		1	Installation Sheet		1

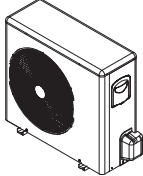
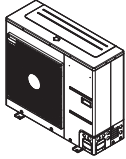
OUTDOOR UNIT BOX		
Item	Image	Quantity
Outdoor unit U3 Chassis (Product heating capacity : 12kW,14kW,16kW)		1
Outdoor unit UE1 Chassis (Product heating capacity : 9kW)		1
Outdoor Unit AHUW096A1 (U4 Chassis) (Product heating capacity : 9kW)		1

Preface

This installation manual is to present information and guide about understanding, installing, and checking **THERMAV**.

Your careful reading before installation is highly appreciated to make no mistake and to prevent potential risks.

The manual is divided into nine chapters. These chapters are classified according to installation procedure.

See the table below to get summarized information.

Chapters	Contents
Chapter 1	<ul style="list-style-type: none"> • Warning and Caution concerned with safety. • This chapter is directly related with human safety. We STRONGLY recommend reading this chapter carefully.
Chapter 2	<ul style="list-style-type: none"> • Fundamental knowledge about THERMAV. • Model identification, accessories information, refrigerant and water cycle diagram, parts and dimensions, electrical wiring diagrams, etc. • This chapter is important to understand THERMAV.
Chapter 3	<ul style="list-style-type: none"> • Installation about the outdoor unit. • Installation location, constraints on installation site, etc
Chapter 4	<ul style="list-style-type: none"> • Installation about the indoor unit. • Installation location, constraints on installation site, etc • Constrains when accessories are installed
Chapter 5	<ul style="list-style-type: none"> • How to perform piping (for refrigerant) and wiring at the outdoor unit. • Refrigerant pipe connection between the indoor unit and the outdoor unit. • Electrical wiring at the outdoor unit.
Chapter 6	<ul style="list-style-type: none"> • How to perform piping (for water) and wiring at the indoor unit. • Water pipe connection between the indoor unit and pre-built under floor water loop pipe. • Electrical wiring at the indoor unit. • System set-up and configuration. • As many control parameters of THERMAV is adjustable by control panel, deep understanding about this chapter is required to secure the operation flexibility of THERMAV. • For more detailed information, please read the separate OPERATION MANUAL to use control panel and adjust control parameters.
Chapter 7	<ul style="list-style-type: none"> • Information about supported accessories • Specification, Constraints, and wiring are described. • Before purchasing accessories, please find supported specification to buy proper one.
Chapter 8	<ul style="list-style-type: none"> • Test operation and check point while test running.
Chapter 9	<ul style="list-style-type: none"> • Check points before starting operation are explained. • Troubleshooting, maintenance, and error code list are presented to correct problems.

REMARK : ALL CONTENTS OF THIS MANUAL ARE SUBJECT TO CHANGE WITHOUT NOTICE. TO GET THE LATEST INFORMATION, PLEASE VISIT LG ELECTRONICS WEB SITE www.lgservice.com

1. Safety Precautions

To prevent injury to the user or other people and property damage, the following instructions must be followed.

- Be sure to read before installing the product.
- Be sure to observe the cautions specified here as they include important items related to safety.
- Incorrect operation due to ignoring instruction will cause harm or damage. The seriousness is classified by the following indications.

⚠ WARNING This symbol indicates the possibility of death or serious injury.

⚠ CAUTION This symbol indicates the possibility of injury or damage to properties only.

■ Meanings of symbols used in this manual are as shown below.



Be sure not to do.



Be sure to follow the instruction.

⚠ WARNING

■ Installation

Do not use a defective or underrated circuit breaker. Use this appliance on a dedicated circuit.

- There is risk of fire or electric shock.

For electrical work, contact the dealer, seller, a qualified electrician, or an Authorized Service Center.

- There is risk of fire or electric shock.

Always ground the product.

- There is risk of fire or electric shock.

Install the panel and the cover of control box securely.

- There is risk of fire or electric shock.

Always install a dedicated circuit and breaker.

- Improper wiring or installation may cause fire or electric shock

Use the correctly rated breaker or fuse.

- There is risk of fire or electric

Do not modify or extend the power cable.

- There is risk of fire or electric shock.

Do not install, remove, or reinstall the unit by yourself (customer).

- There is risk of fire, electric shock, explosion, or injury

Be cautious when unpacking and installing the product.

- Sharp edges could cause injury. Especially careful on the product edges and the fins on the heat exchanger.

For installation, always contact the dealer or an Authorized Service Center.

- There is risk of fire, electric shock, explosion, or injury.

Do not install the product on a defective installation stand.

- It may cause injury, accident, or damage to the product.

Be sure the installation area does not deteriorate with age.

- If the base collapses, the product could fall with it, causing property damage, product failure, and personal injury.

■ Operation

Do not let the product run for a long time when the humidity is very high and a door or a window is left open.

- Moisture may be condensed and wet or damage furniture.

Take care to ensure that power cable could not be pulled out or damaged during operation.

- There is risk of fire or electric shock.

Do not place anything on the power cable.

- There is risk of fire or electric shock.

Do not plug or unplug the power supply plug during operation.

- There is risk of fire or electric shock.

Do not touch (operate) the product with wet hands.

- There is risk of fire or electric shock.

Do not place a heater or other appliances near the power cable.

- There is risk of fire or electric shock.

Do not allow water to run into electric parts.

- There is risk of fire, failure of the product, or electric shock.

Do not store or use flammable gas or combustibles near the product.

- There is risk of fire or failure of product.

Do not use the product in a tightly closed space for a long time.

- Oxygen deficiency could occur.

When flammable gas leaks, turn off the gas and open a window for ventilation before turn the product on.

- There is risk of explosion or fire.

If strange sounds, or small or smoke comes from product, turn the breaker off or disconnect the power supply cable.

- There is risk of electric shock or fire.

Stop operation and close the window in storm or hurricane. If possible, remove the product from the window before the hurricane arrives.

- There is risk of property damage, failure of product, or electric shock.

Do not open the front cover of the indoor unit while operation. (Do not touch the electrostatic filter, if the unit is so equipped.)

- There is risk of physical injury, electric shock, or product failure.

When the product is soaked (flooded or submerged), contact an Authorized Service Center.

- There is risk of fire or electric shock.

Be cautious that water could not be poured to the product directly.

- There is risk of fire, electric shock, or product damage.

Ventilate the product from time to time when operating it together with a stove, etc.

- There is risk of fire or electric shock.

Turn the main power off when cleaning or maintaining the product.

- There is risk of electric shock.

Take care to ensure that nobody could step on or fall onto the outdoor unit.

- This could result in personal injury and product damage.

Special warning about no operation for long-time

- If the product is not used for long time, we strongly recommend NOT TO SWITCH OFF THE POWER SUPPLY to the product.
- If power is not supplied, some special product-protecting actions (such as water pump anti-locking) will not be performed.

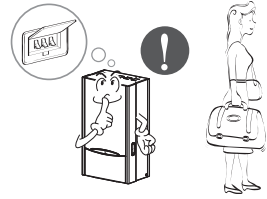
**CAUTION****■ Installation**

Always check for gas (refrigerant) leakage after installation or repair of product.

- Low refrigerant levels may cause failure of product.

Do not install the product where it will be exposed to sea wind (salt spray) directly.

- It may cause corrosion on the product. Corrosion, particularly on the condenser and evaporator fins, could cause product malfunction or inefficient operation.

Keep level even when installing the product.

- To avoid vibration or water leakage.

Do not install the product where the noise or hot air from the outdoor unit could damage the neighborhoods.

- It may cause a problem for your neighbors.

Use two or more people to lift and transport the product.

- Avoid personal injury.

■ Operation

Do not lay on the cooled floor for long time when the product is in cooling operation.

- This could harm to your health.

Do not use the product for special purposes, such as preserving foods, works of art, etc. It is a consumer product, not a precision refrigeration system.

- There is risk of damage or loss of property.

Do not block the outlet of air flow.

- It may cause product failure.

Use a soft cloth to clean. Do not use harsh detergents, solvents, etc.

- There is risk of fire, electric shock, or damage to the plastic parts of the product.

Do not step on or put anything on the product. (outdoor units)

- There is risk of personal injury and failure of product.

Do not insert hands or other objects into the product while it is operating.

- There are sharp and moving parts that could cause personal injury.

Use a firm stool or ladder when cleaning or maintaining the product.

- Be careful and avoid personal injury.

At low outdoor temperature, the product will display "CH44"

- It may cause a problem for product.

2. General Information

With advanced inverter technology, **THERMAV** is suitable for applications like under floor heating, under floor cooling, and hot water generation. By Interfacing to various accessories user can customize the range of the application.

In this chapter, general information of **THERMAV** is presented to identify the installation procedure. Before beginning installation, read this chapter carefully and find helpful information on installation.

Model Information

Model number nomenclature

A	H	—	W	0	9	6	A	0
---	---	---	---	---	---	---	---	---

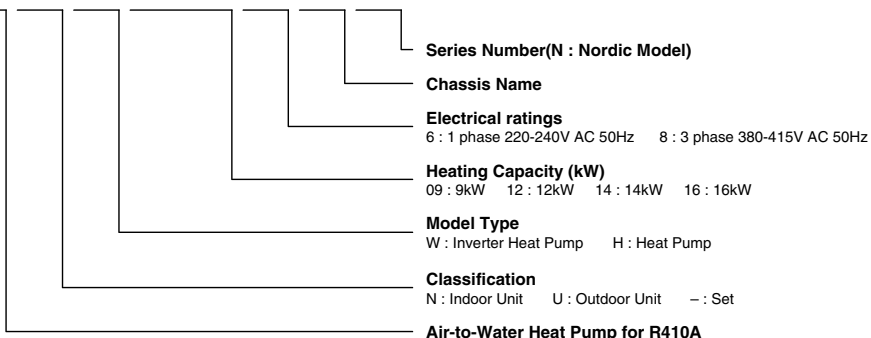

A	H	N	W	0	9	A	0	6	A	0
---	---	---	---	---	---	---	---	---	---	---

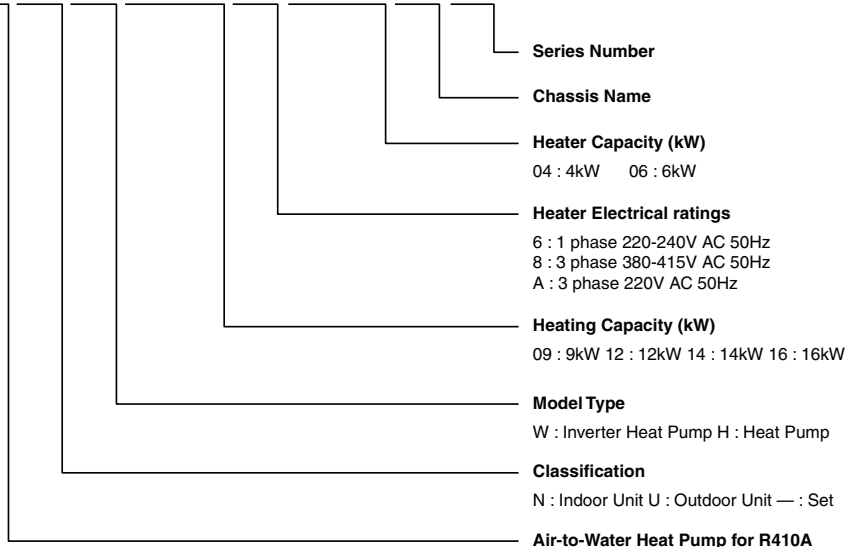

Model name and related information

Model Name			Built-In Electric Heater(kW)	Power Source (Electric Heater)	Capacity		Power Source (Unit)
Set	Outdoor Unit	Indoor Unit			Heating(kW) ^{*1}	Cooling(kW) ^{*1}	
AH-W096A0	AHUW096A0	AHNW096A0	4(2+2)	1~ 220V-240V 50Hz	9	8.6	1~ 220V-240V 50Hz
AH-W126A0	AHUW126A0	AHNW126A0	6(3+3)		12	14	
AH-W146A0	AHUW146A0	AHNW146A0			14	14	
AH-W166A0	AHUW166A0	AHNW166A0			16	14	
-	AHUW096A1	AHNW09604A1	4(2+2)		9	9	
-	AHUW096AN	AHNW09606A0	6(3+3)	3N~ 220V 50Hz 3N~ 380V-415V 50Hz	9	8.6	
-		AHNW09A06A0	6(2+2+2)				
-		AHNW09806A0	6(3+3)				
-	AHUW128A1	AHNW16606A1	6(3+3)	1~ 220V-240V 50Hz	12	17.8	3N~ 380V-415V 50Hz
-		AHNW16A06A1	6(2+2+2)	3N~ 220V 50Hz			
-		AHNW16806A1	6(2+2+2)	3N~ 380V-415V 50Hz			
-	AHUW148A1	AHNW16606A1	6(3+3)	1~ 220V-240V 50Hz	14	16.1	3N~ 380V-415V 50Hz
-		AHNW16A06A1	6(2+2+2)	3N~ 220V 50Hz			
-		AHNW16806A1	6(2+2+2)	3N~ 380V-415V 50Hz			
-	AHUW168A1	AHNW16606A1	6(3+3)	1~ 220V-240V 50Hz	16	15.1	3N~ 380V-415V 50Hz
-		AHNW16A06A1	6(2+2+2)	3N~ 220V 50Hz			
-		AHNW16806A1	6(2+2+2)	3N~ 380V-415V 50Hz			
-	AHUW166A1	AHNW16606A1	6(3+3)	1~ 220V-240V 50Hz	16	16.1	1~ 220V-240V 50Hz
-	AHUW146A1				14	15.5	
-	AHUW126A1				12	14.5	
-	AHUW146A2	AHNW16606A1	6(3+3)	1~ 220V-240V 50Hz	14	14	1~ 220V-240V 50Hz
-		AHNW16A06A1	6(2+2+2)	3N~ 220V 50Hz			
-		AHNW16806A1	6(2+2+2)	3N~ 380V-415V 50Hz			
-	AHUW126A2	AHNW16606A1	6(3+3)	1~ 220V-240V 50Hz	12	12	1~ 220V-240V 50Hz
-		AHNW16A06A1	6(2+2+2)	3N~ 220V 50Hz			
-		AHNW16806A1	6(2+2+2)	3N~ 380V-415V 50Hz			

*1 : tested under Eurovent Heating condition
(water temperature 30°C → 35°C at outdoor ambient temperature 7°C / 6°C)

*2 : tested under Eurovent Cooling condition
(water temperature 23°C → 18°C at outdoor ambient temperature 35°C / 24°C)

3 : All appliances were tested at atmospheric pressure.

Accessories

To extend the functionality of **THERMAV**, there are various external auxiliary apparatus called as 'accessories.'

They are classified by 'accessories' and '3rd party accessories' according to the manufacturer. Accessories are presented LG Electronics, and 3rd party accessories are presented by related manufacturers.

Accessories supported by LG Electronics

Item	Purpose	Model
Sanitary Water Tank Install Kit	To operate with sanitary water tank	PHLTA
Remote Air Sensor	To control by air temperature	PQRSTA0
Dry Contact	To receive on & off external signal	PQDSA
Solar Heating Kit	To operate with solar heating system	PHLLA (Limit Temperature : 96°C)
		PHLLB (Limit Temperature : 120°C)
Sanitary Water Tank	To generate and store hot water	PHS02060310 : 200 liter, Single Heating Coil, 1Ø 230V 50Hz 3kW Electric Heater PHS02060320 : 200 liter, Double Heating Coil, 1Ø 230V 50Hz 3kW Electric Heater PHS03060310 : 300 liter, Single Heating Coil, 1Ø 230V 50Hz 3kW Electric Heater PHS03060320 : 300 liter, Double Heating Coil, 1Ø 230V 50Hz 3kW Electric Heater

Accessories supported by 3rd party Companies

Item	Purpose	Specification
Solar Heating System	To generate auxiliary heating energy for water tank	
Thermostat	To control by air temperature	Heating-Only type (230V AC or 24V AC) Cooling/Heating type (230V AC or 24V AC with Mode selection switch)
3way valve and actuator	To control water flow for hot water heating or floor heating	3 wire, SPDT (Single Pole Double Throw) type, 230V AC
2way valve and actuator	To control water flow for Fan Coil Unit	2 wire, NO(Normal Open) or NC(Normal Closed) type, 230V AC

Typical Installation Example

⚠ CAUTION

If **THERMAV** is installed with pre-existing boiler, the boiler and THERMA V should not be operated together. If entering water temperature of **THERMAV** is above 55°C, the system will stop operation to prevent mechanical damage of the product. For detailed electric wiring and water piping, please contact authorized installer.

Some installation scenes are presented for example. As these scenes are conceptual figures, installer should optimize the installation scene according to the installation conditions.

CASE 1: Connecting Heat Emitters for Heating and Cooling

(Under floor loop, Fan Coil Unit, and Radiator)

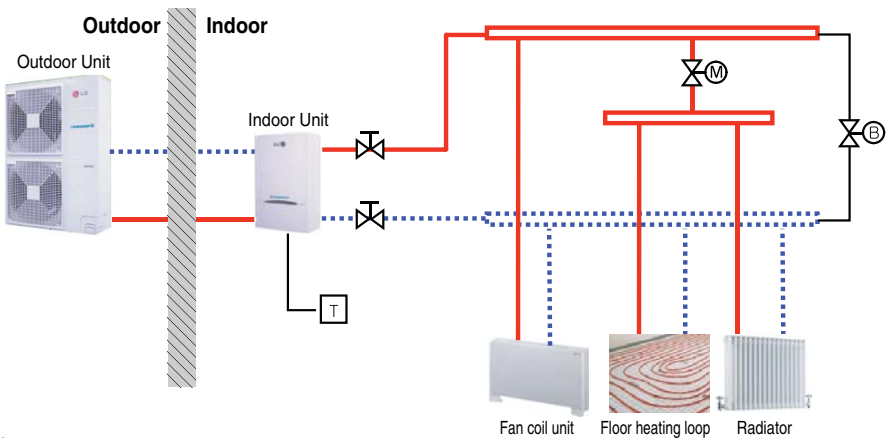

Note:

- Room thermostat
 - Type of thermostat and specification should be complied with chapter 4 and chapter 7 of **THERMAV** installation manual.
- 2way valve
 - It is important to install 2way valve to prevent dew condensation on the floor and radiator while cooling mode.
 - Type of 2way control valve and specification should be complied with chapter 4 and chapter 7 of **THERMAV** installation manual.
 - 2way valve should be installed at the supply side of the collector.
- By-pass valve
 - To secure enough water flow rate, by-pass valve should be installed at the collector.
 - By-pass valve should guarantee minimum water flow rate in any case. Minimum water flow rate is described in water pump characteristics curve.

— High Temperature



Room Thermostat(Field supply)



Shut-off valve

..... Low Temperature



2way valve
(Field supply)



By-pass valve(Field supply)

CASE 2: Connecting Sanitary Water Tank

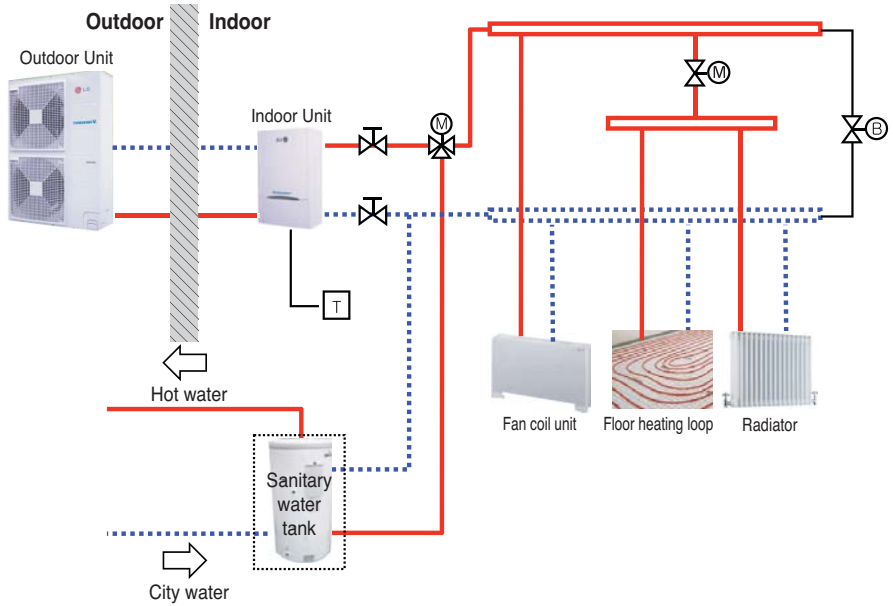

Note:

- Sanitary water tank
 - It should be equipped with internal electric heater to generate sufficient heat energy in very cold season.
- 3way valve
 - Type of 3way valve and specification should be complied with chapter 4 and chapter 7 of **THERMAV** installation manual.

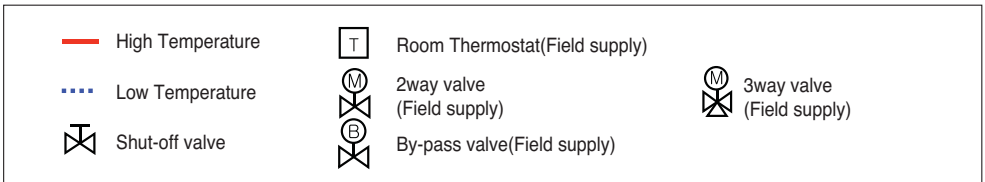

CASE 3: Connecting Solar thermal system

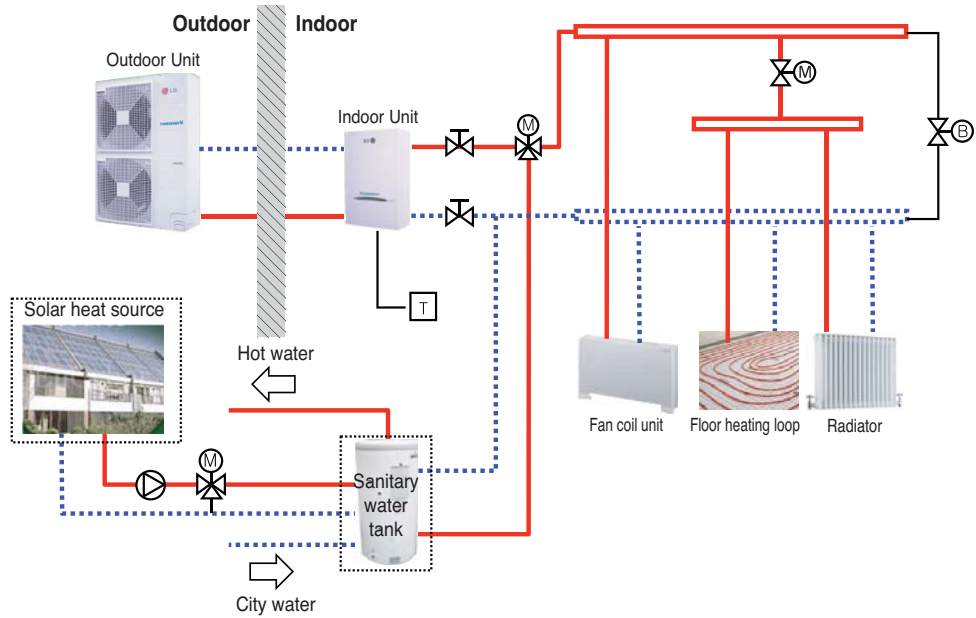

ENGLISH

Note:

- Sanitary water tank
 - It should have additional indirect heat exchanger to utilize heat energy by solar thermal system.
- Pump
 - Maximum power consumption of pump should be less than 0.25kW.

	High Temperature		Room Thermostat(Field supply)		3way valve (Field supply)
	Low Temperature		2way valve (Field supply)		Pump(Field supply)
	Shut-off valve		By-pass valve(Field supply)		

Cycle Diagram

Refrigerant Cycle(Non-Vapor Injection)

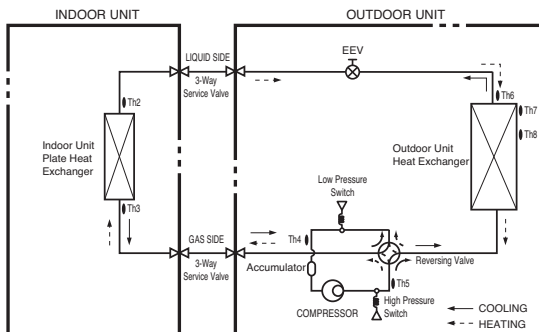

Description

Category	Symbol	Meaning	PCB Connector	Remarks
Indoor Unit	Th1	Remote air temperature sensor	CN_ROOM	- Optional accessory (being sold separately) - Not shown in diagram
	Th2	Inlet evaporator temperature sensor	CN_PIPE	- Meaning is expressed based on Cooling mode.
	Th3	Outlet evaporator temperature sensor	CN_PIPE/O	- Meaning is expressed based on Cooling mode.
Outdoor Unit	Th4	Compressor-suction pipe temperature sensor	CN_TH3	- Th4 and Th5 are connected at 4 pin type connector CN_TH3.
	Th5	Compressor-discharge pipe temperature sensor	CN_TH3	- Th4 and Th5 are connected at 4 pin type connector CN_TH3.
	Th6	Condenser temperature sensor	CN_TH2	- Description is expressed based on Cooling mode.
	Th7	Outdoor air temperature sensor	CN_TH2	- Th6 and Th7 are connected at 4 pin type connector CN_TH2
	Th8 ^{*1}	Condenser middle temperature sensor	CN_TH3	- Th8 is connected at 4 pin type connector CN_TH3
	EEV	Electronic Expansion Valve	CN_LEV1	

*1:Applied Model : AHUW128A1, AHUW148A1, AHUW168A1, AHUW096A1, AHUW126A1, AHUW146A1, AHUW166A1

Refrigerant Cycle(Vapor Injection)

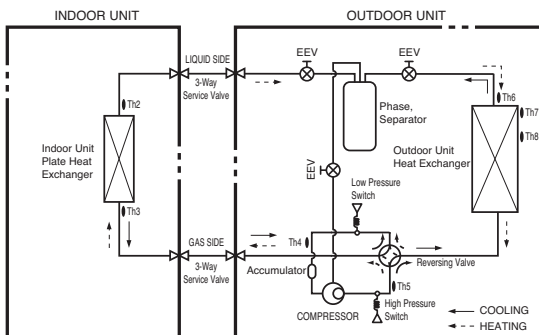

Description

Category	Symbol	Meaning	PCB Connector	Remarks
Indoor Unit	Th1	Remote air temperature sensor	CN_ROOM	- Optional accessory (being sold separately) - Not shown in diagram
	Th2	Inlet evaporator temperature sensor	CN_PIPE	- Meaning is expressed based on Cooling mode.
	Th3	Outlet evaporator temperature sensor	CN_PIPE/O	- Meaning is expressed based on Cooling mode.
Outdoor Unit	Th4	Compressor-suction pipe temperature sensor	CN_TH3	- Th4 and Th5 are connected at 4 pin type connector CN_TH3.
	Th5	Compressor-discharge pipe temperature sensor	CN_TH3	- Th4 and Th5 are connected at 4 pin type connector CN_TH3.
	Th6	Condenser temperature sensor	CN_TH2	- Description is expressed based on Cooling mode.
	Th7	Outdoor air temperature sensor	CN_TH2	- Th6 and Th7 are connected at 4 pin type connector CN_TH2
	Th8	Condenser middle temperature sensor	CN_TH3	- Th8 is connected at 4 pin type connector CN_TH3
	EEV	Electronic Expansion Valve	CN_LEV1 CN_LEV2 CN_LEV3	- Adjusting mass flow rate of circulating refrigerant or injecting refrigerant

Water cycle

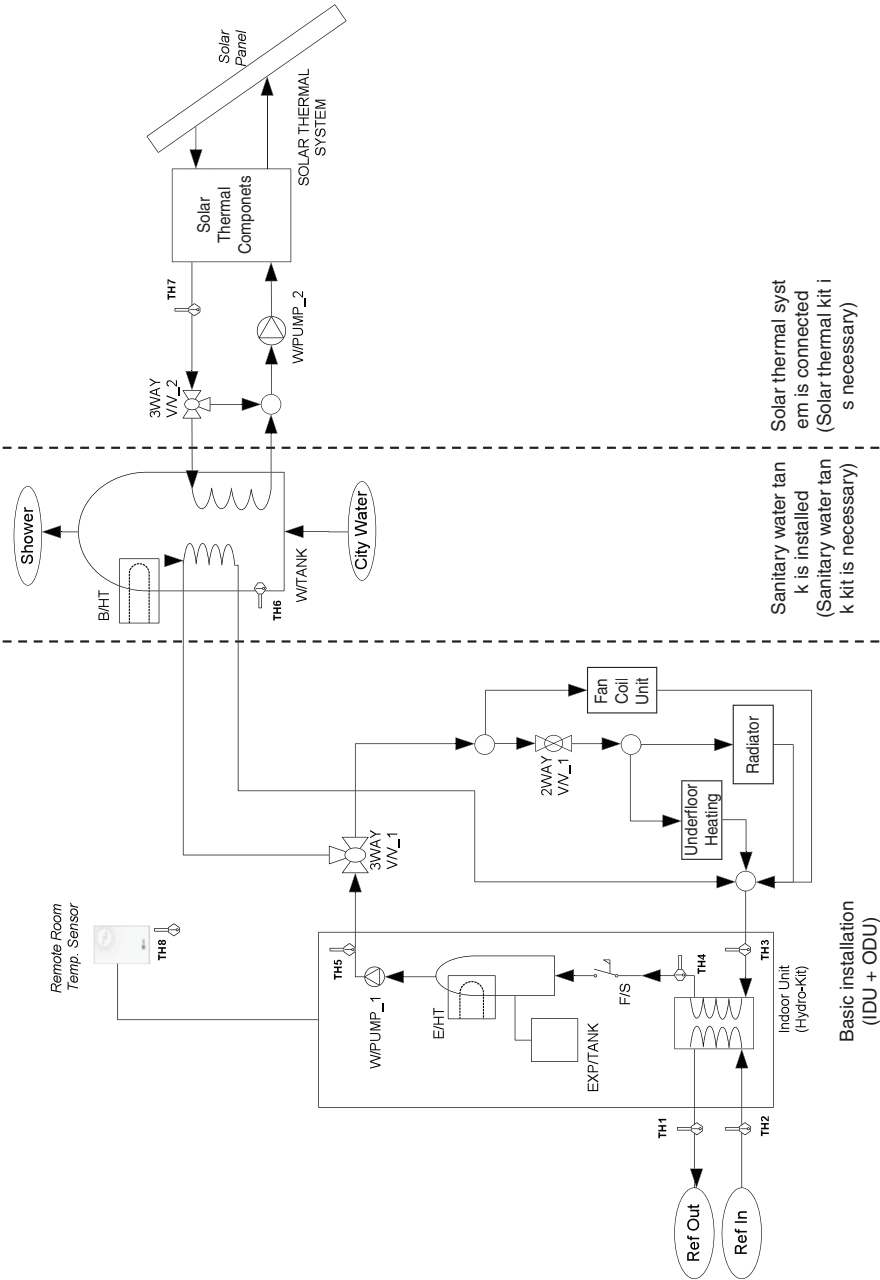

Solar thermal system is connected (Solar thermal kit is necessary)

Sanitary water tank is installed (Sanitary water tank kit is necessary)

Basic installation (IDU + ODU)

Description

Category	Symbol	Meaning	PCB Connector	Remarks
Indoor Unit	TH1	Refrigerant temperature sensor (Gas side)	CN_PIPE/OUT	- Meaning is expressed based on Cooling mode.
	TH2	Refrigerant temperature sensor (Liquid side)	CN_PIPE	
	TH3	Entering Water temperature sensor	CN_TH3	- TH3, TH4, and TH5 are connected at 6 pin type connector CN_TH3.
	TH4	Interim Water temperature sensor		
	TH5	Leaving Water temperature sensor		
	F/S	Flow Switch	CN_FLOW1	
	E/HT	Electric Heater	CN_E/HEAT(A) CN_E/HEAT(B)	- Heating capacity is divided into two level : partial capacity by E/HEAT(A) and full capacity by E/HEAT(A) + E/HEAT(B). - Operating power(230V AC 50Hz) of E/HEAT(A) and E/HEAT(B) are supplied by external power source via relay connector and ELB.
	W_PUMP1	Internal Water Pump	CN_W/PUMP(A)	- Operating power(230V AC 50Hz) of internal water pump is supplied by the connector.
	EXP/TANK	Expansion Tank	(no connector)	- Absorb volume change of heated water,
	TH8	Remote Air temperature sensor	CN_ROOM	- Optional accessory (sold separately) - Model : PQRSTA0
CTR/PNL	Control Panel (or 'Remote Controller')	CN_REMO	- Pre built-in at indoor unit	
2WAY V/V_1	To control water flow for Fan Coil Unit	CN_2WAY(A)	- 3rd party accessory and Field installation (sold separately) - 2wire NO or NC type 2way valve is supported.	
Water Heating	W/TANK	Sanitary Water Tank	(no connector)	- 3rd party accessory and Field installation (sold separately) - Generating and storing sanitary hot water by AWHP or built-in electric heater-
	B/HT	Electric Heater	CN_B/HEAT(A)	- 3rd party accessory and Field installation (usually built-in at W/TANK) - Supplying additional water heating capacity.
	3WAY V/V_1	- Flow control for water which is leaving from indoor unit. - Flow direction switching between under-floor and water tank	CN_3WAY(A)	- 3rd party accessory and Field installation (sold separately) - SPDT type 3way valve is supported.
	CITY WATER	Water to be heated by Indoor unit and B/HT of W/TANK	(no connector)	- Field installation
	SHOWER	Water supplied to end-user	(no connector)	- Field installation
	TH6	W/TANK water temperature sensor	CN_TH4	- TH6 and TH7 are connected at 4 pin type connector CN_TH4. - TH6 is a part of sanitary water tank kit. (Model:PHLTA) - TH7 is a part of solar thermal kit (Model:PHLLA)
TH7	Solar-heated water temperature sensor			
Solar Heating	3WAY V/V_2	- Flow control for water which is heated and circulated by SOLAR THERMAL SYSTEM. - Flow direction switching between SOLAR THERMAL SYSTEM and W/TANK	CN_3WAY(B)	- 3rd party accessory and Field installation (sold separately) - SPDT type 3way valve is supported.
	W_PUMP/2	External Water Pump	CN_W/PUMP(B)	- 3rd party accessory and Field installation (sold separately) - If water pump of SOLAR THERMAL SYSTEM is incapable of circulation,external water pump can be used.
	SOLAR THERMAL SYSTEM	- This system can include following components : Solar panel, Sensors, Thermostats, Interim heat exchanger, Water pump, etc. - To utilized hot water heated by SOLAR THERMAL SYSTEM, end-user must by LG AWHP Solar-Kit.	(no connector)	- 3rd party accessory and Field installation (sold separately)

Parts and Dimensions

Indoor unit(External)

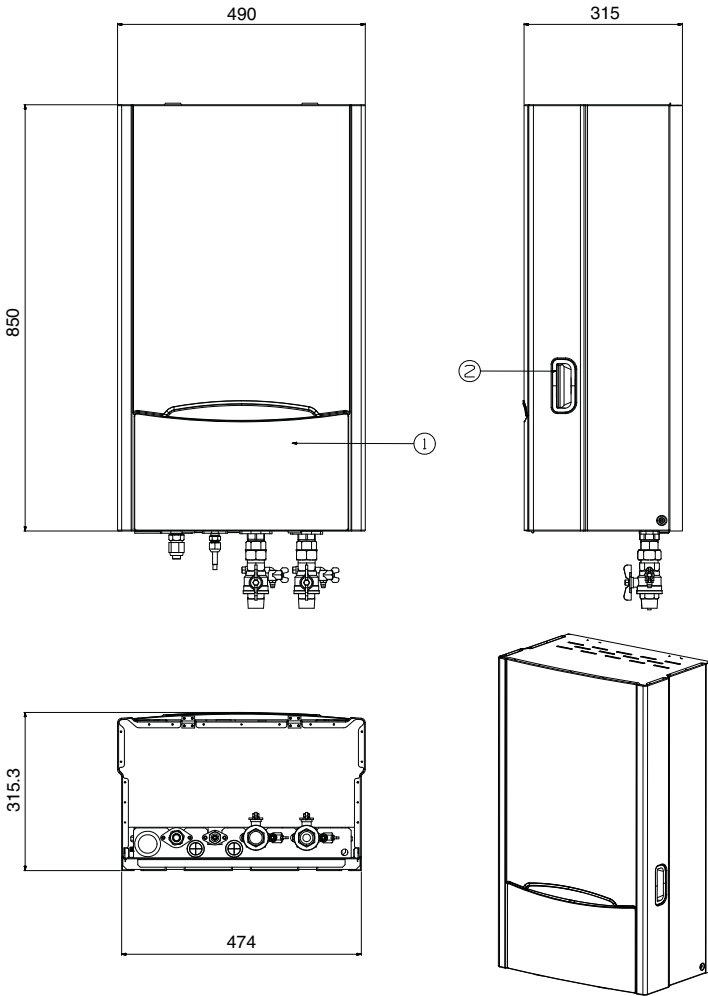

Description

(unit:mm)

No	Name	Remarks
1	Door	Control panel is shown after this door is opened.
2	Handle	Used to cover or uncover the front case

Indoor unit(Internal)

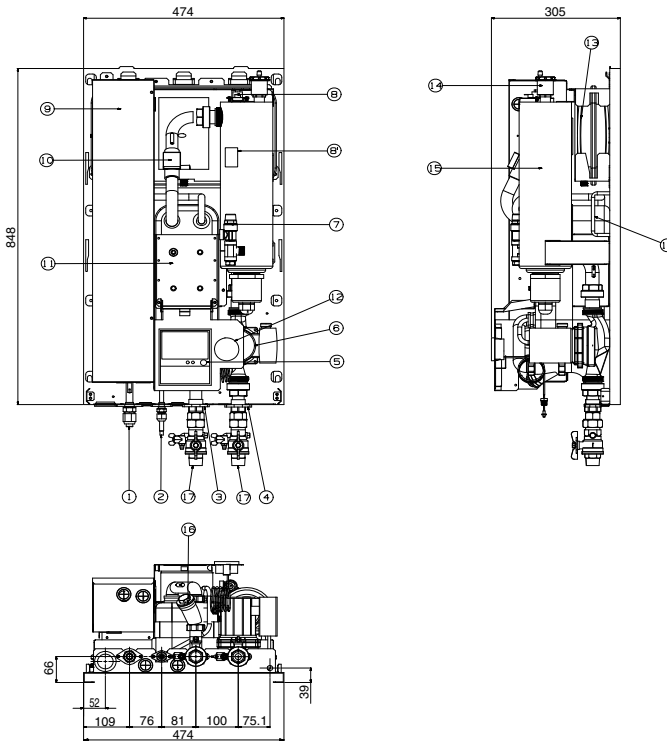

Description

(unit:mm)

No	Name	Remarks
1	Refrigerant Pipe	Ø15.88mm
2	Refrigerant Pipe	Ø9.52mm
3	Entering Water Pipe	Male PT 1 inch
4	Leaving Water Pipe	Male PT 1 inch
5	Control Panel	Built-in Remote Controller
6	Water Pump	Max Head 7.5 / 6.5 m
7	Safety Valve	Open at water pressure 3 bar
8	Thermal switch	Cut-off power input to electric heater at 90 C (manual return at 55C) (1Ø Electric Heater is applied)
8'	Thermal switch	Cut-off power input to electric heater at 90 C (manual return at 55 C) (3Ø Electric Heater is applied)
9	Control Box	PCB and terminal blocks
10	Flow Switch	Minimum operation range at 12 LPM. (9kW) Minimum operation range at 15 LPM. (12kW, 14kW, 16kW)
11	Plate Heat Exchanger	Heat exchange between refrigerant and water
12	Pressure Gage	Indicates circulating water pressure
13	Expansion Tank	Absorbing Volume change of heated water
14	Air Vent	Air purging when Charging water
15	Electric Heater	Please refer Page 12
16	Strainer	Filtering and stacking particles inside circulating water
17	Shut-off valve	To drain or to block water when pipe connecting
18	Carrying handle	To carry the product

Outdoor unit(External)

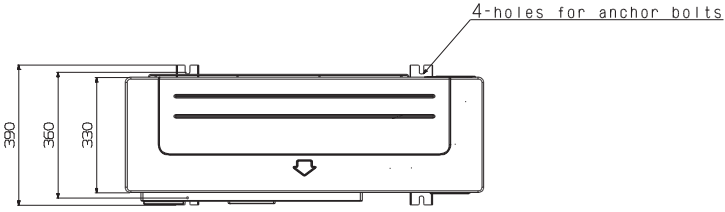

Product Heating Capacity :
12kW,14kW,16kW
U3 Chassis
(unit:mm)

ENGLISH

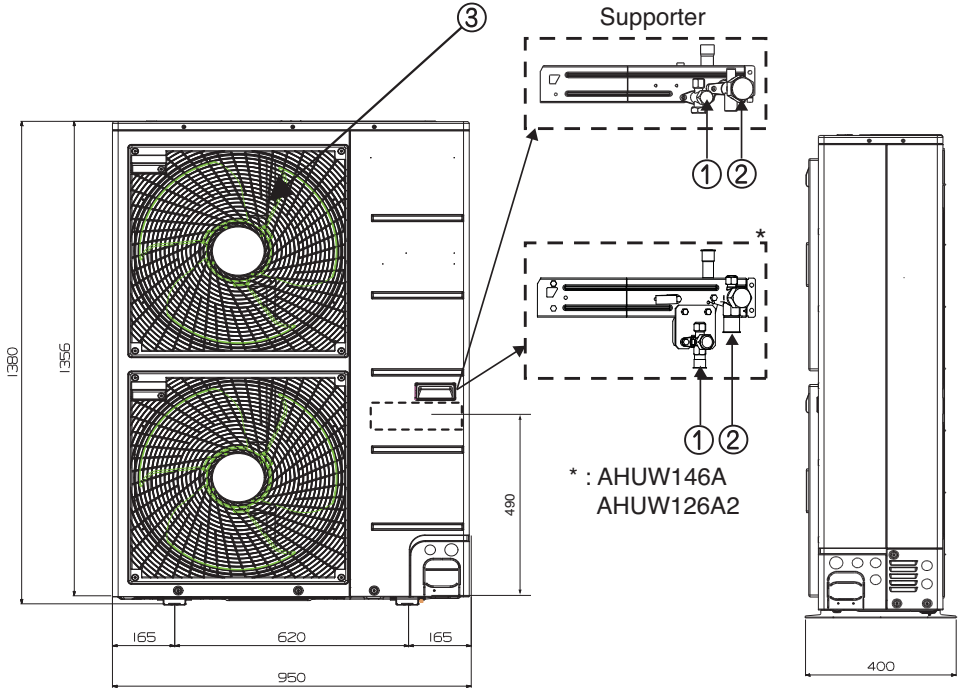

Description

No	Name
1	Liquid-side Service Valve
2	Gas-side Service Valve
3	Air discharge Grill

Product Heating Capacity : 9kW
UE1 Chassis
 (unit:mm)

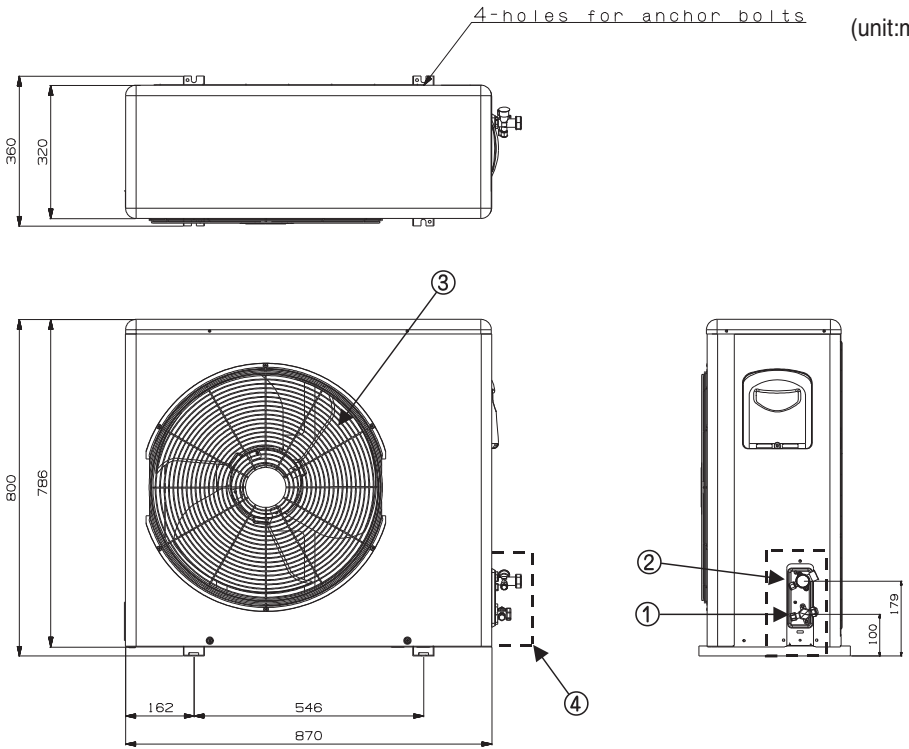

Description

No	Name
1	Liquid-side Service Valve
2	Gas-side Service Valve
3	Air discharge Grill
4	Cover

Product Heating Capacity : 9kW
U4 Chassis
 (unit:mm)

ENGLISH

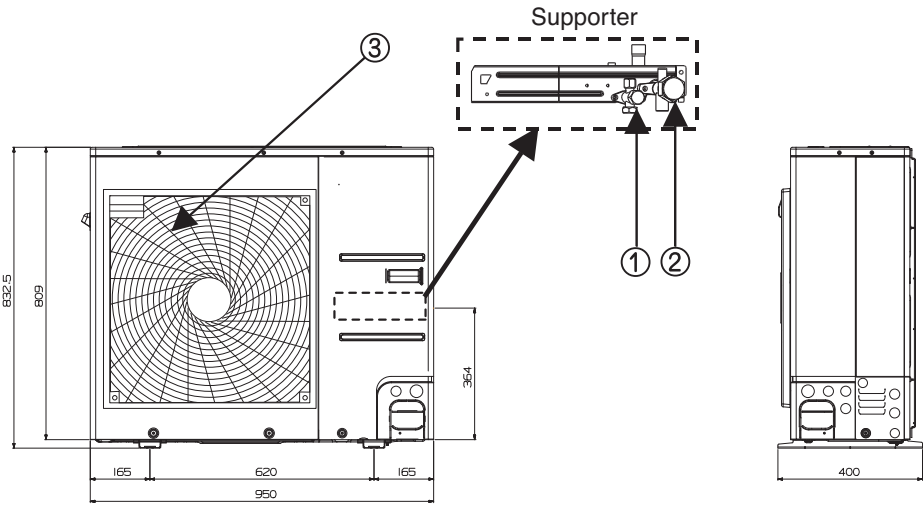
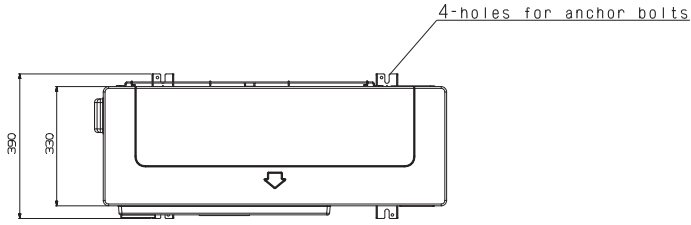

Description

No	Name
1	Liquid-side Service Valve
2	Gas-side Service Valve
3	Air discharge Grill

Control Parts

Control Box : Indoor Unit

1Ø Electric Heater

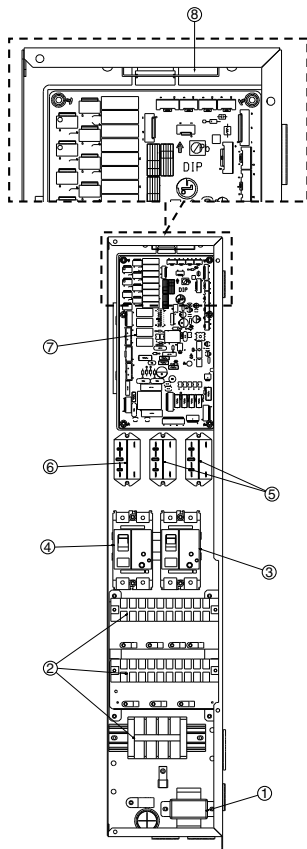

3Ø Electric Heater

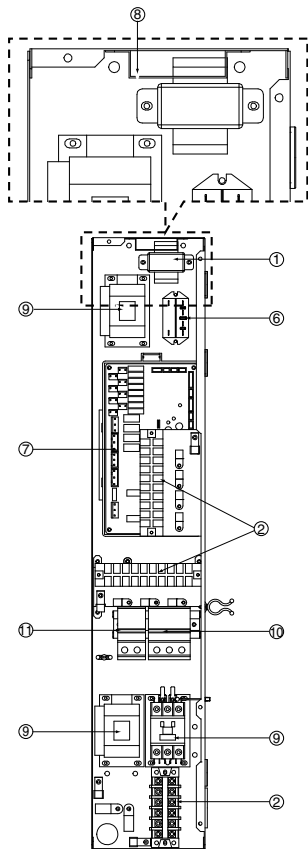

Description

No	Name	Remarks
1	Down transformer	Voltage down(230V AC → 24V AC)
2	Terminal blocks	The terminal blocks allow easy connection of field wiring
3	Unit ELB	The ELB protects the unit against overload or short circuit
4	Water tank heater ELB(optional)	The ELB protects the water tank heater in sanitary water tank against overload or short circuit
5	Relays	-
6	Relay (optional for water tank heater)	-
7	Main PCB	The main PCB(Printed Circuit Board) controls the functioning of the unit
8	Dry Contact Supporter	Supporter to install Dry Contact (sold separately)
9	Magnet Contact	
10	Unit MCCB	The MCCB protects the unit against overload
11	Water tank heater MCCB(optional)	The MCCB protects the water tank heater in sanitary water tank against overload

Control Panel

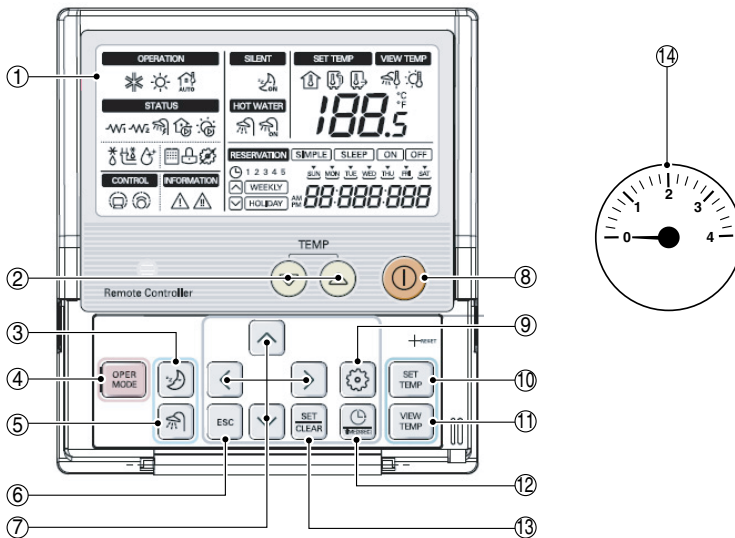

Description

No	Name
1	Display Panel
2	Change Temperature Button
3	Silent Mode On / Off Button
4	Operation Mode Selection Button
5	Water Heating Enable / Disable Button
6	ESC Button
7	Direction Button (Up, Down, Left, Right)
8	Power Button
9	Function Setting Button
10	Temperature Setting Mode Button
11	Temperature View Mode Button
12	Programming Button
13	Set / Clear button
14	Pressure gage

Wiring Diagram : Indoor Unit

- Refer to the wiring diagram inside the control box.

Circuit Diagram : Indoor Unit

- Refer to the circuit diagram inside the front panel.

Wiring Diagram : Outdoor Unit

- Refer to the attached wiring diagram in the outdoor unit.

Wiring Diagram : Indoor and Outdoor Unit(Including Field wiring) (Indoor : Electric Heater 1Ø, Outdoor : 1Ø)

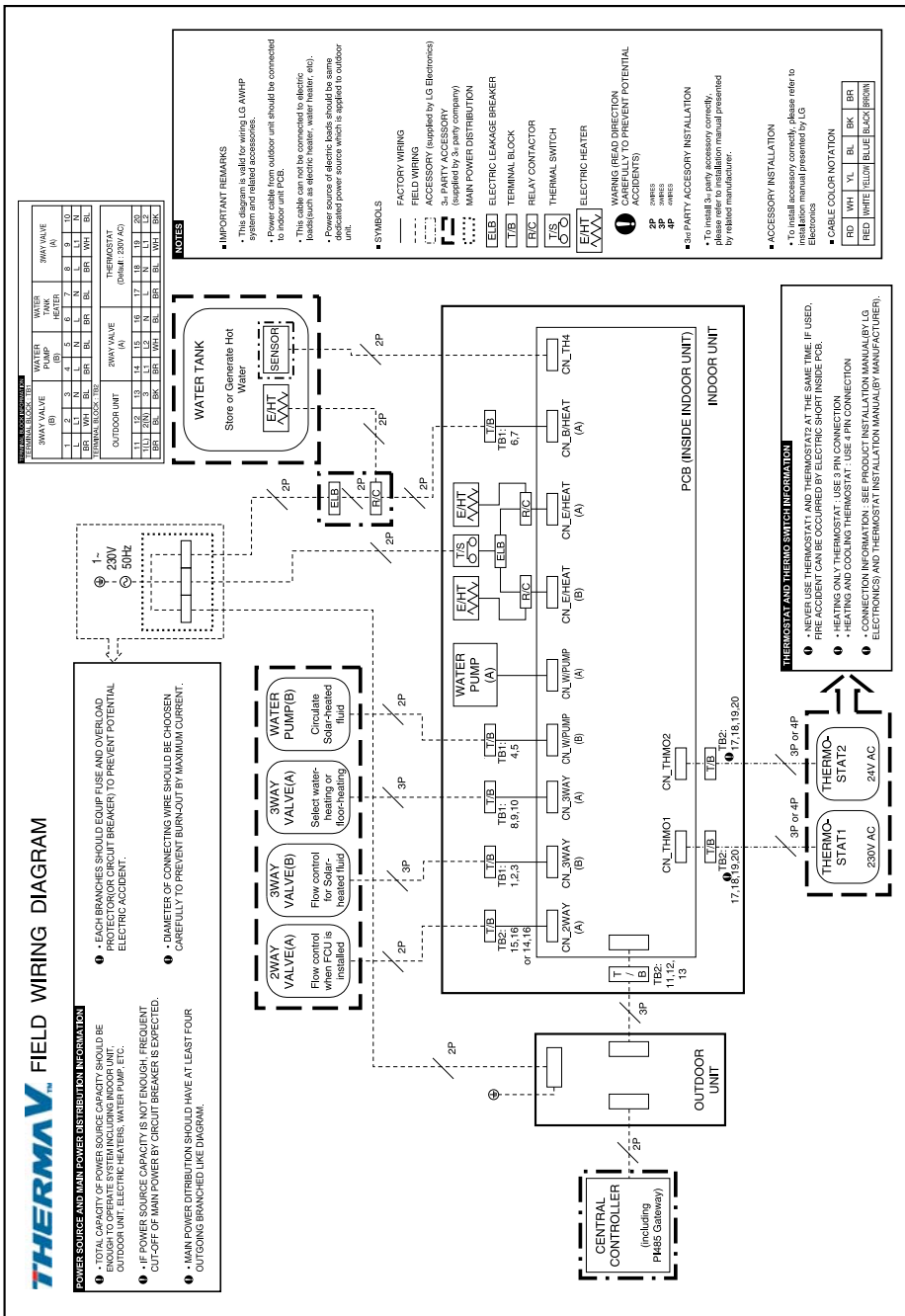

Wiring Diagram : Indoor and Outdoor Unit(Including Field wiring) (Indoor : Electric Heater 3Ø, Outdoor : 1Ø)

ENGLISH

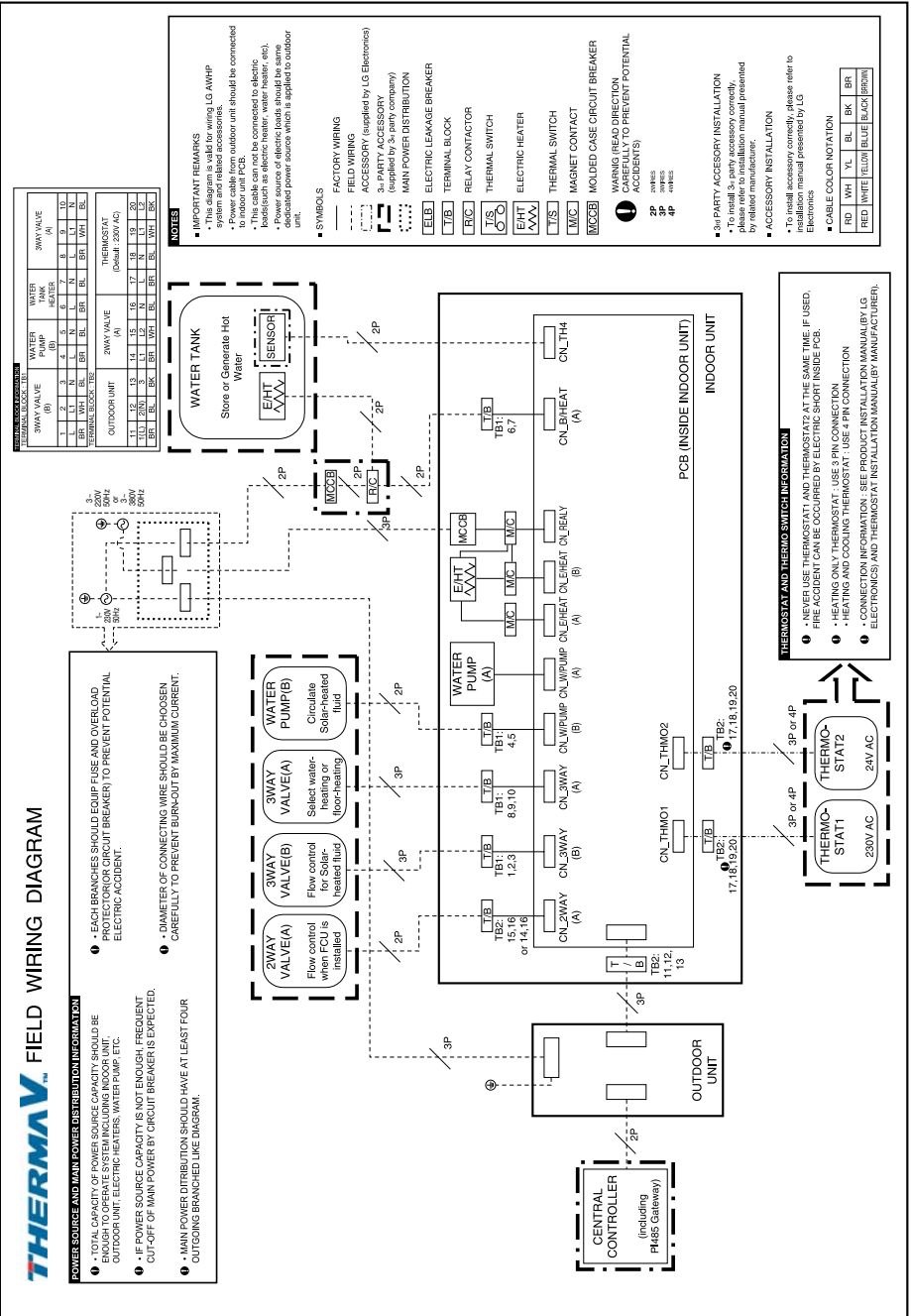

Wiring Diagram : Indoor and Outdoor Unit(Including Field wiring) (Indoor : Electric Heater 3Ø 220V, Outdoor : 3Ø)

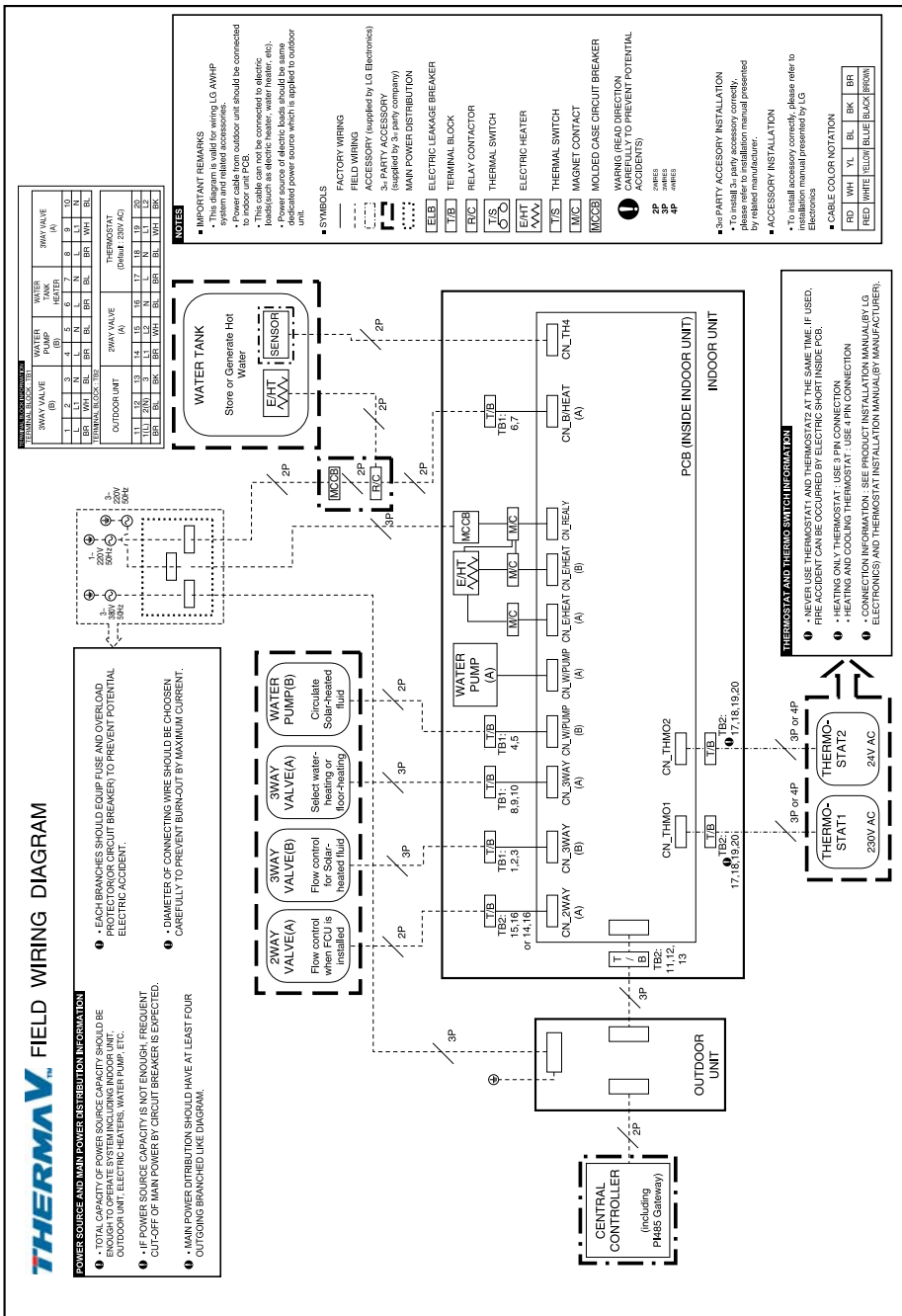

Wiring Diagram : Indoor and Outdoor Unit(Including Field wiring) (Indoor : Electric Heater 3Ø 380-415V, Outdoor : 3Ø)

ENGLISH

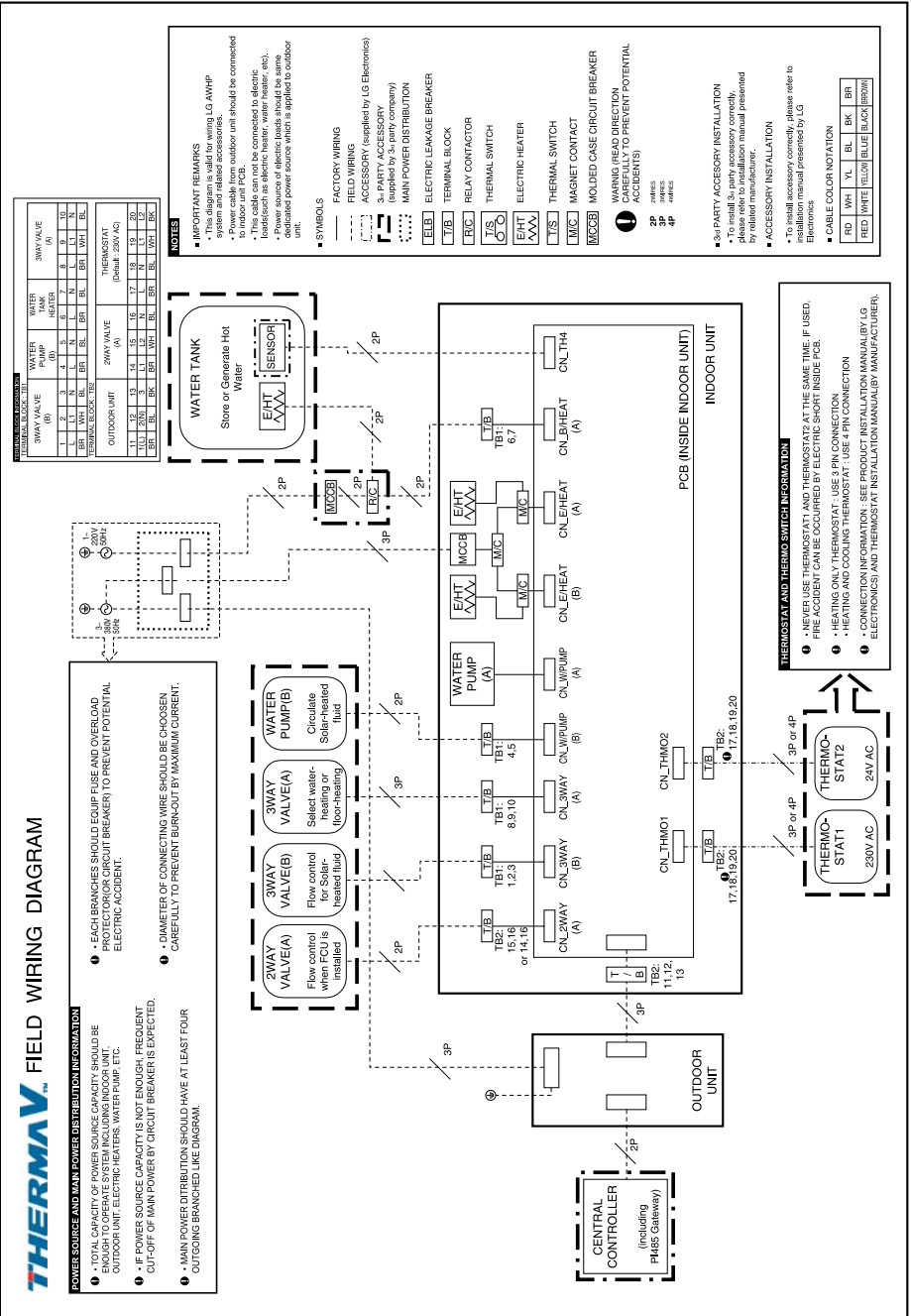

THERMAV™ FIELD WIRING DIAGRAM

- EACH BRANCHES SHOULD EQUIP FUSE AND OVERLOAD PROTECTOR (OR CIRCUIT BREAKER) TO PREVENT POTENTIAL ELECTRIC ACCIDENT.
- CATEGORIES OF CONNECTING WIRE SHOULD BE CHOSEN CAREFULLY TO PREVENT BURNOUT BY MAXIMUM CURRENT.

- **2WAY VALVE(A)** Flow control for Solenoid heater (Pump)
- **3WAY VALVE(B)** Flow control for Solenoid heater (Pump)
- **3WAY VALVE(A)** Select water-heating or flow (Pump)
- **3WAY VALVE(B)** Select water-heating or flow (Pump)
- **WATER PUMP(B)** Circulate Solenoid-heated fluid

THERMOSTAT AND THERMO SWITCH INFORMATION

- NEVER USE THERMOSTAT AND THERMO SWITCH AT THE SAME TIME. IF USED, FIRE ACCIDENT CAN BE OCCURRED BY ELECTRIC SHORT INSIDE PCB.
- HEATING ONLY THERMOSTAT : USE 3-PIN CONNECTION
- HEATING AND COOLING THERMOSTAT : USE 4-PIN CONNECTION
- CONNECTION INFORMATION : SEE PRODUCT INSTALLATION MANUAL BY LG ELECTRONICS) AND THERMOSTAT INSTALLATION MANUAL BY MANUFACTURER.

3. Installation of Outdoor Unit

The outdoor unit of **THERMAV** is installed outside to exchange heat with ambient air. Therefore, it is important to secure proper space around the outdoor unit and care for specific external conditions.

This chapter presents a guide to install the outdoor unit, make a route to connect with the indoor, and what to do when installed around seaside.

Conditions where Outdoor Unit is Installed

- If a sunroof is built over the unit to prevent direct sunlight or rain exposure, make sure that heat radiation from the heat exchanger is not restricted.
- Ensure that the spaces indicated by arrows around front, back and side of the unit.
- Do not place animals and plants in the path of the warm air.
- Take the weight of the outdoor unit into account and select a place where noise and vibration are minimum.
- Select a place so that the warm air and noise from the outdoor unit do not disturb neighbors.

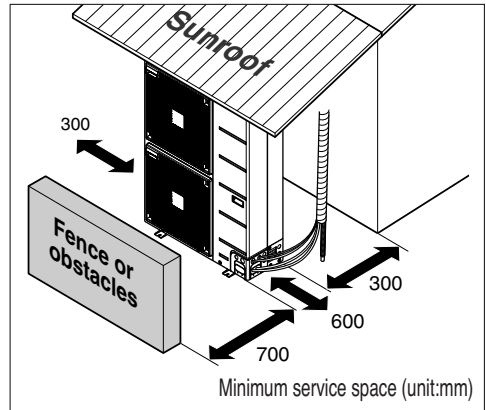

Drill a Hole in the Wall

- If making a hole to the wall is required to connect pipe between the indoor unit and the outdoor unit, please follow below descriptions.
 - Drill the piping hole with a $\phi 70\text{mm}$ hole core drill.
 - Piping hole should be slightly slant to the outdoor side to prevent raindrop into indoor side.

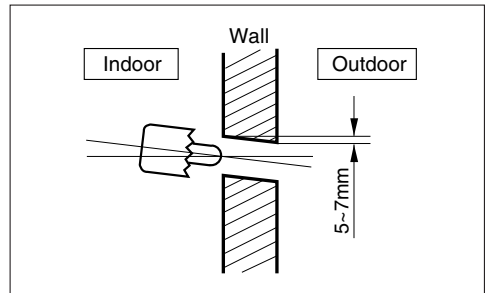

Installation at Seaside



CAUTION

1. Air conditioners should not be installed in areas where corrosive gases, such as acid or alkaline gas, are produced.
2. Do not install the product where it could be exposed to sea wind (salty wind) directly. It can result corrosion on the product. Corrosion, particularly on the condenser and evaporator fins, could cause product malfunction or inefficient performance.
3. If outdoor unit is installed close to the seaside, it should avoid direct exposure to the sea wind. Otherwise it needs additional anticorrosion treatment on the heat exchanger.

Selecting the location(Outdoor Unit)

- 1) If the outdoor unit is to be installed close to the seaside, direct exposure to the sea wind should be avoided. Install the outdoor unit on the opposite side of the sea wind direction.

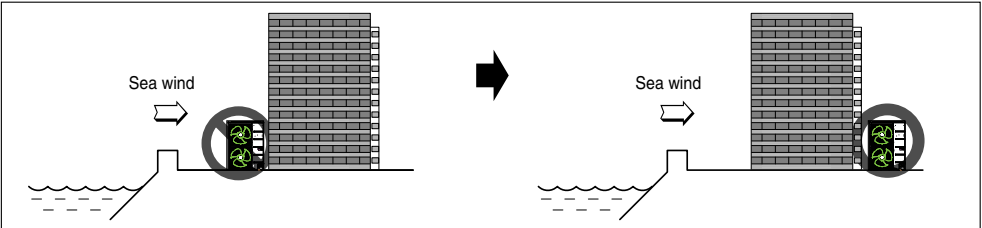

- 2) In case, to install the outdoor unit on the seaside, set up a windbreak not to be exposed to the sea wind.

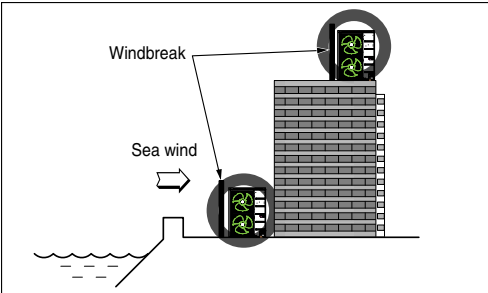

- It should be strong enough like concrete to prevent the sea wind from the sea.
- The height and width should be more than 150% of the outdoor unit.
- It should be keep more than 700 mm of space between outdoor unit and the windbreak for easy air flow.

- 3) Select a well-drained place.

1. If you can't meet above guide line in the seaside installation, please contact LG Electronics for the additional anticorrosion treatment.
2. Periodic (more than once/year) cleaning of the dust or salt particles stuck on the heat exchanger by using water

Seasonal wind and cautions in winter

- Sufficient measures are required in a snow area or severe cold area in winter so that product can be operated well.
- Get ready for seasonal wind or snow in winter even in other areas.
- Install a suction and discharge duct not to let in snow or rain.
- Install the outdoor unit not to come in contact with snow directly. If snow piles up and freezes on the air suction hole, the system may malfunction. If it is installed at snowy area, attach the hood to the system.
- Install the outdoor unit at the higher installation console by 500 mm than the average snowfall (annual average snowfall) if it is installed at the area with much snowfall.
- Where snow accumulated on the upper part of the Outdoor Unit by more than 100 mm, always remove snow for operation.

1. The height of H frame must be more than 2 times the snowfall and its width shall not exceed the width of the product. (If width of the frame is wider than that of the product, snow may accumulate)
2. Don't install the suction hole and discharge hole of the Outdoor Unit facing the seasonal wind.

4. Installation of Indoor Unit

The indoor unit of **THERMAV** is installed inside where terminal of under floor water pipe cycle and refrigerant pipe from the outdoor unit are accessible at the same time.

In this chapter conditions for installation place is described. In addition, considerations when installing accessories or 3rd party accessories are described, too.

Conditions where Indoor Unit is Installed

Specific conditions are required for installation place such as service space, wall mounting, water pipe length and height, total volume of water, adjusting expansion vessel, and water quality.

General Considerations

Followings are should be considered before the installation of the indoor unit.

- The installation place should be free from outdoor weather conditions such as rain, snow, wind, frost, etc.
- Choose the place where is water-resistant or good drainage.
- Service space should be secured.
- No flammable materials around the indoor unit.
- Mice can not be appeared to prevent entering the indoor unit or attacking wires.
- Do not place anything in front of the indoor unit to ensure air circulation around the indoor unit.
- Do not locate anything under the indoor unit to be free from unexpected water out.
- In case of water pressure increasing to 3 bar, water drainage should be treated when water is drained by safety valve.

Service Space

- Ensure that the spaces indicated by arrows around bottom, side, and top side.
- Wider spaces are preferred for easy maintenance and piping.
- If minimum service space is not secured, air circulation can be troubled and internal parts of the indoor unit can be damaged by overheating.

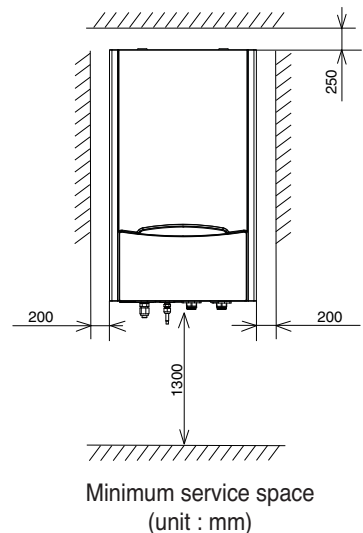

Mounting to Wall

Step 1. After releasing eight screws, detach front cover from the indoor unit. While detaching the front cover, grab the carrying handles at left and right sides of the front cover. Then pull into upward direction. When assemble the front cover, remove detached side brackets of the front cover and ONLY tighten two screws of bottom.

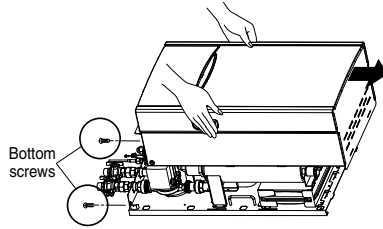
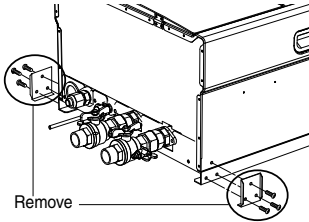

Step 2. Attach "Installation Sheet" to the wall and mark the location of bolts. This sheet helps to find correct location to the bolts.

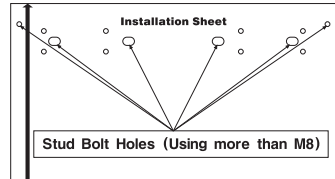

⚠ CAUTION

The sheet should be attached level. If not, the supporting plate and the indoor unit will not be mounted correctly.

Step 3. Detach the Installation sheet. Screw bolts with supporting plate at the hole marks on the wall. When screwing bolts, use M8 ~ M11 anchor bolts to secure hanging the indoor unit.

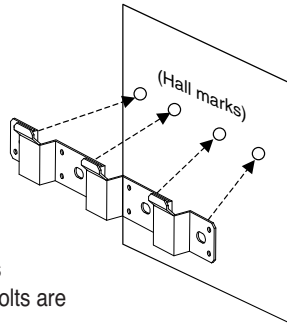

ⓘ NOTICE

Eight small holes around four large hole marks can be used as alternatives of M8 ~ M11 anchor bolts. But M8 ~ M11 anchor bolts are more preferred.

Step 4. Hang the indoor unit at the supporting plate. Also, catch the carrying handles at left and right sides of the indoor unit.

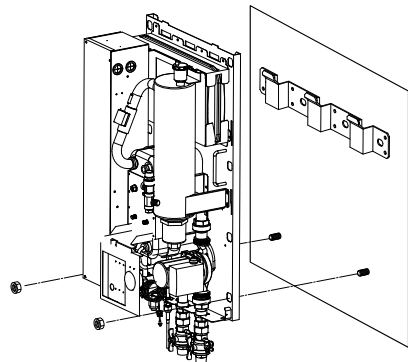

⚠ CAUTION

While lifting the indoor unit, at least two persons should be joined. Weight of the indoor unit is almost 55kg.

Water Volume and Pump Capacity

THERMAV has different internal water pump according to the product capacity.

The water pump is three speed-adjustable (Maximum / Medium / Minimum), so it may be required to change default water pump speed in case of noise by water flow. In most case, however, it is strongly recommended to set speed as Maximum.

! NOTICE

Water pump speed

To secure enough water flow rate, do not set water pump speed as 'Min.' It can lead unexpected flow rate error CH14.

Product Heating Capacity : 9kW

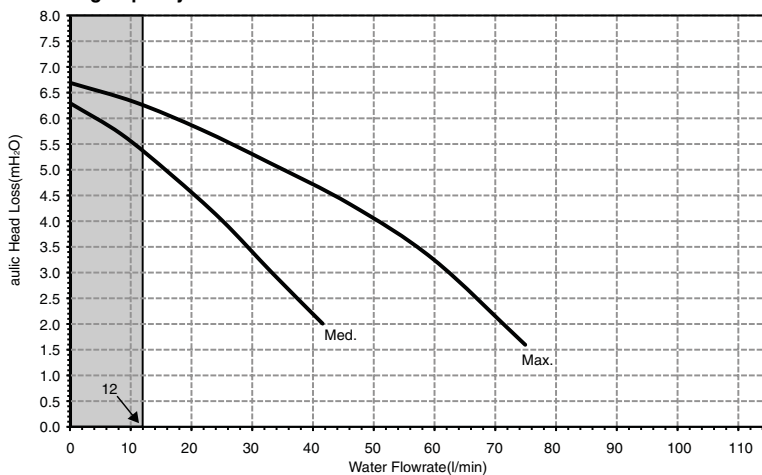

Product Heating Capacity : 12kW,14kW,16kW

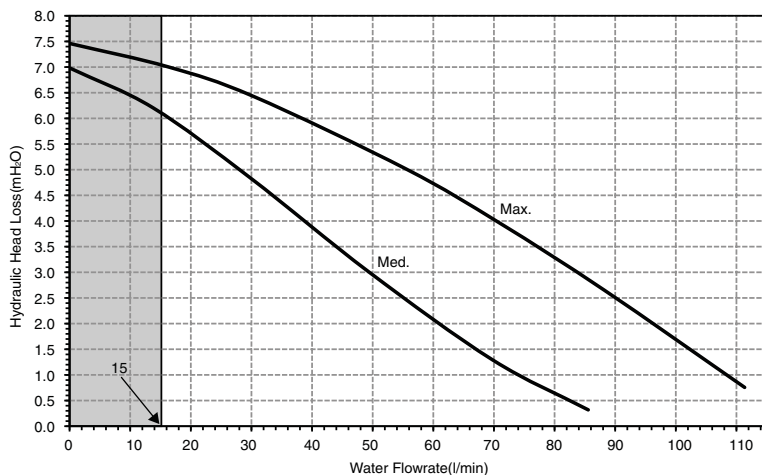

Max. : high speed setting

Med. : low speed setting

Warning : Selecting a water flowrate outside the curves can cause damage to or malfunction of the unit.

■ : Operation cutoff range

Water Volume and Expansion Vessel Pressure

Inside **THERMAV** expansion vessel is included which is 8 liter capacity with 1 bar pre-pressure. That means, according to the volume-pressure graph, total water volume of 230 liter is supported as default. If total water volume is changed because of installation condition, the pre-pressure should be adjusted to secure proper operation.

- Minimum total water volume is 20 liter.
- Pre-pressure is adjusted by the total water volume. If the indoor unit is located at the highest position of the water circuit, adjustment is not required.
- To adjust pre-pressure, use nitrogen gas by certificated installer.

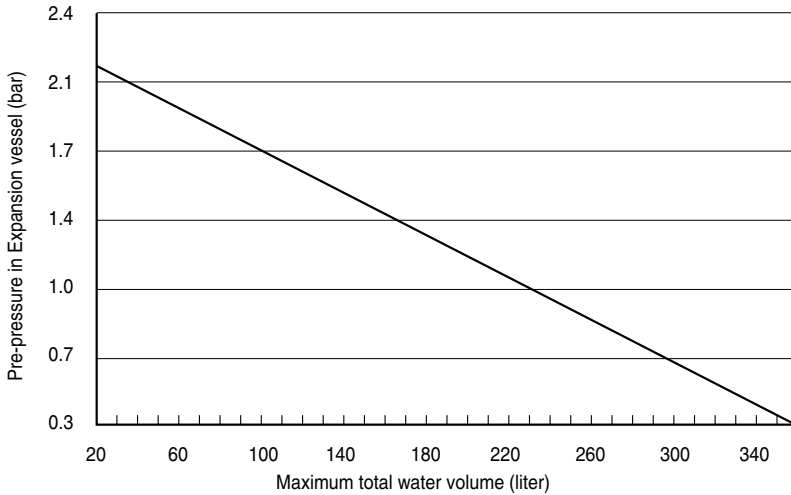

Adjusting pre-pressure of expansion vessel is as following :

Step 1. Refer "Volume-Height" table.

If installation scene is belong to Case A, go to Step 2.

Otherwise, if it is Case B, do nothing. (pre-pressure adjustment is not required.)

Otherwise, if it is Case C, go to Step 3.

Step 2. Adjust pre-pressure by following equation.

$$\text{Pre-pressure [bar]} = (0.1 \times H + 0.3) \text{ [bar]}$$

where H : difference between indoor unit and the highest water pipe

0.3 : minimum water pressure to secure product operation

Step 3. Volume of expansion vessel is less than installation scene.

Please install additional expansion vessel at the external water circuit.

Volume-Height Table

	V < 230 liter	V ≥ 230 liter
H < 7m	Case B	Case A
H ≥ 7m	Case A	Case C

H : difference between indoor unit and the highest water pipe

V : total water volume of installation scene

Water Quality

Water quality should be complied with EN 98/83 EC Directives. Requirement for resolved chemical ingredients is following table. Detailed water quality condition can be found in EN 98/83 EC Directives.

Parameter	Value	Parameter	Value
Acrylamide	0.10 $\mu\text{g/l}$	Fluoride	1.5 mg/l
Antimony	5.0 $\mu\text{g/l}$	Lead	10 $\mu\text{g/l}$
Arsenic	10 $\mu\text{g/l}$	Mercury	1.0 $\mu\text{g/l}$
Benzene	1.0 $\mu\text{g/l}$	Nickel	20 $\mu\text{g/l}$
Benzo(a)pyrene	0.010 $\mu\text{g/l}$	Nitrate	50 mg/l
Boron	1.0 mg/l	Nitrite	0.50 mg/l
Bromate	10 $\mu\text{g/l}$	Pesticides	0.10 $\mu\text{g/l}$
Cadmium	5.0 $\mu\text{g/l}$	Pesticides — Total	0.50 $\mu\text{g/l}$
Chromium	50 $\mu\text{g/l}$	Polycyclic aromatic hydrocarbons	0.10 $\mu\text{g/l}$
Copper	2.0 mg/l	Selenium	10 $\mu\text{g/l}$
Cyanide	50 $\mu\text{g/l}$	Tetrachloroethene and Trichloroethene	10 $\mu\text{g/l}$
1,2-dichloroethane	3.0 $\mu\text{g/l}$	Trihalomethanes — Total	100 $\mu\text{g/l}$
Epichlorohydrin	0.10 $\mu\text{g/l}$	Vinyl chloride	0.50 $\mu\text{g/l}$

CAUTION

- If the product is installed at existing hydraulic water loop, it is important to clean hydraulic pipes to remove sludge and scale.
- Installing sludge strainer in the water loop is very important to prevent performance degrade.
- Chemical treatment to prevent rust should be performed by installer.

Conditions if Accessories are Installed

This section describes conditions about installation place where accessories are installed. Detailed installation for accessories (including supported accessory specification, wiring, PCB setting for accessory configuration, etc) will be dealt in separated chapter.

Thermostat

⚠ CAUTION

1. NEVER USE 230V AC Thermostat and 24V AC Thermostat at the same time. If used together, it causes short-circuit and yields power cut-off by circuit breaker.
2. Some electro-mechanical type thermostat has internal delay time to protect compressor. In that case, mode change can takes time more than user's expectation. Please read thermostat manual carefully if the product does not response quickly.
3. Setting temperature range by thermostat can be different with that of the product. The heating or cooling set temperature should be chosen within the setting temperature range of the product.
4. It is highly recommended that the thermostat should be installed where space heating is mainly applied.

Following location should be avoid to secure proper operation :

- Height from floor is approximately 1.5 m.
- Thermostat can not be located where the area may be hidden when door is open.
- Thermostat can not be located where external thermal influence may be applied. (such as above heating radiator or open window)

Remote Air Temperature Sensor

Role and constraint while installation of remote air temperature sensor is very similar to that of thermostat.

- Distance between the indoor unit and the remote air temperature sensor should be less than 15 m due to length of the connection cable of remote air temperature sensor.
- For other constraints, please refer to previous page where constraints about thermostat is described

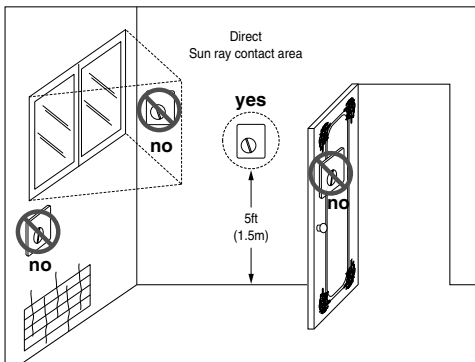

Thermostat

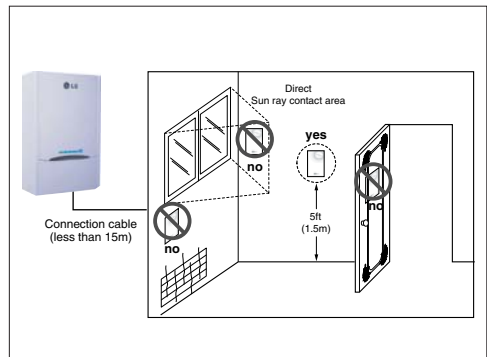

Remote Air Temperature Sensor

Sanitary Water Tank and Sanitary Water Tank Kit / Solar Thermal Kit

Installing sanitary water tank requires following considerations :

- Sanitary water tank should be located at the flat place.
- Water quality should be complied with EN 98/83 EC Directives.
- As this water tank is sanitary water tank (indirect heat exchange), do not use anti water-freezing treatment like ethylene glycol.
- It is highly recommend to wash out inside of the sanitary water tank after installation. It ensures generating clean hot water.
- Near the sanitary water tank there should be water supply and water drain to easy access and maintenance.
- Set the maximum value of the temperature control device of sanitary tank.

While installing sanitary water tank with sanitary water tank kit or solar thermal kit, there are some constraints like below :

- Sanitary water tank should be located under the indoor unit or same height with the indoor unit.
- Sanitary water tank should be located under the solar thermal system.
- Distance between sanitary water tank sensor or solar thermal sensor should be less than 5 m.
- If there is AC power cable near the sensor cable, the sensor cable should be away from the AC power cable at least 5 m to prevent electric noise.

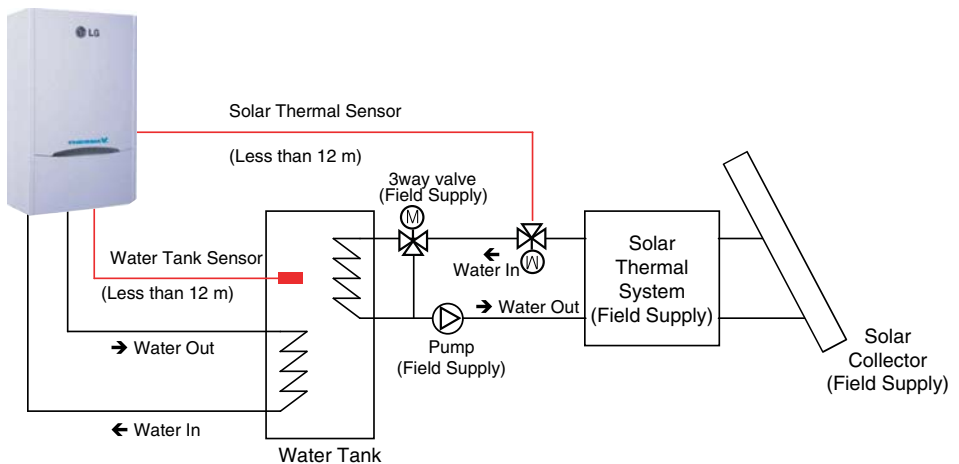

⚠ WARNING

Installing recirculation pump

When **THERMAV** is used with sanitary water tank, it is **STRONGLY** recommended to install recirculation pump to prevent flooding out cold water at the end of hot water supply and to stabilize the water temperature inside the sanitary water tank

- The recirculation pump should be operated when sanitary water demand is not required. Therefore, external time scheduler to determine when the recirculation pump should turn on and turn off is required.
- The operating duration time of the recirculation pump is calculated as follow :
 Duration time [minute] = $k \times V \times R$
 k : 1.2 ~ 1.5 is recommended. (If distance between pump and tank is far, then choose high number)
 V : Volume of sanitary water tank [liter]
 R : Water flow rate of pump [liter per minute], which is determined by pump performance curve
- The pump operating start time should be prior to the sanitary water demand.

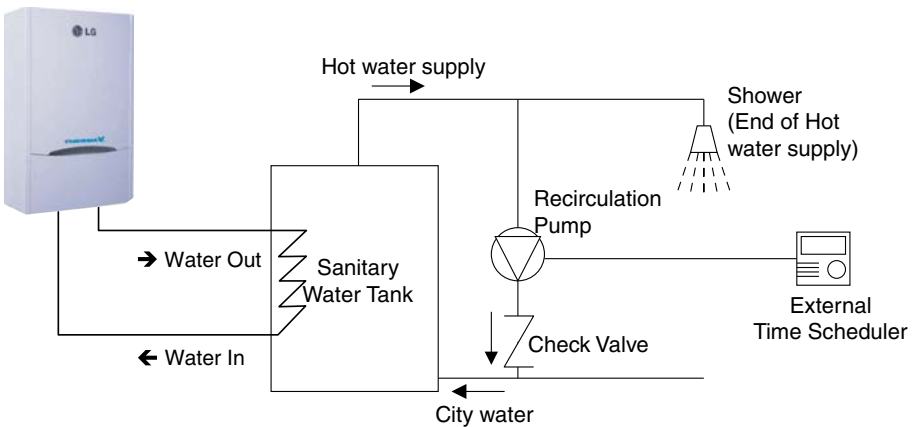

2Way(3way) Valve

2Way(3way) valve should be located between the indoor unit and the water tank.

- If enough space is not secured, the 2Way(3way) valve can be partially located inside the indoor unit by cutting out the bottom of the indoor unit.

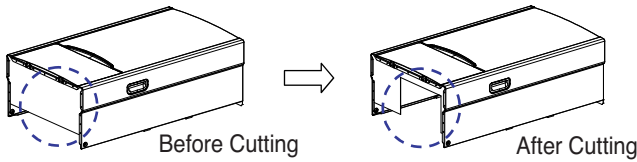

⚠ WARNING

Mice can not be appeared to prevent entering the indoor unit or attacking wires.

⚠ CAUTION

After cutting out the bottom of the indoor unit, remove all burrs completely. Burrs could cause personal injury.

2Way valve should be located between the indoor unit and the water entering point to the under floor. See below picture to identify clearly.

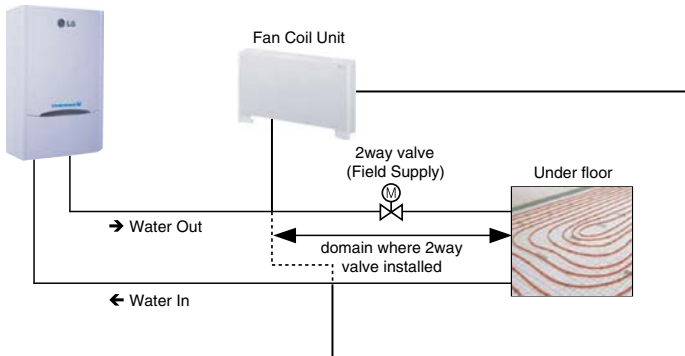

5. Piping and Wiring for Outdoor Unit

Procedures about refrigerant piping and electric wiring at the outdoor are described in this chapter. Most of procedures are similar to those of LG Air Conditioner.

Refrigerant Piping

Before starting refrigerant piping, constraints in pipe length and elevation should be examined. After resolving all constraints, some preparations are required to proceed. Then connecting pipe to the outdoor and the indoor unit is beginning.

Constraints in Pipe Length and Elevation

Type	Capacity	Pipe Size (mm : inch) (Diameter : Ø)		Length A (m)		Elevation B (m)		*Additional Refrigerant (g/m)
		Gas	Liquid	Standard	Max.	Standard	Max.	
Non-Vapor Injection	9kW	15.88(5/8")	9.52(3/8")	7.5	50	0	30	30
	12kW	15.88(5/8")	9.52(3/8")	7.5	50	0	30	60
	14kW							
16kW								
Vapor Injection	9kW	15.88(5/8")	9.52(3/8")	7.5	50	0	30	30
	12kW 14kW	15.88(5/8")	9.52(3/8")	7.5	50	0	30	50

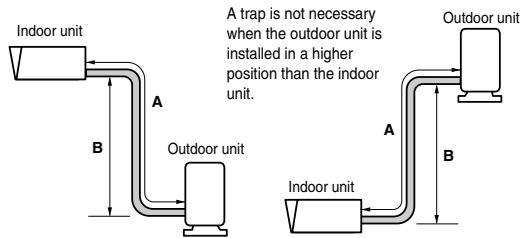

CAUTION

- Standard pipe length is 7.5m and no additional charge of the refrigerant is needed to maximum 15m. If the pipe length is longer than 15m, additional charge of the refrigerant is required according to the table.
 - Example : If 16kW model is installed at a distance of 50m, 2,100g of refrigerant should be added according to following formula : $(50-15) \times 60g = 2,100g$
- Rated capacity of the product is based on standard length and maximum allowable length is based on the product reliability in the operation.
- Improper refrigerant charge may result in abnormal operation.

Note:

Fill in the f-gas Label attached on outdoor about the quantity of the fluorinated greenhouse gases (This note about f-gas label may not apply depending on your product type or market.)

- Manufacturing site (See Model Name label)
- Installation site (If possible being placed adjacent to the service points for the addition or removal of refrigerant)
- The total Charge (① + ②)

Preparation for Piping

Preparation for piping is five steps. As main cause of refrigerant leakage is defects in flaring work, please carry out correct flaring work in the following steps.

Step 1. Cut the pipes and the cable.

- Use the accessory piping kit or the pipes purchased locally.
- Measure the distance between the indoor unit and the outdoor unit.
- Cut the pipes a little longer than measured distance.

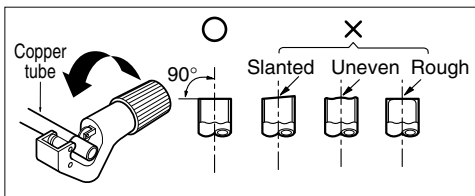

Step 2. Burrs removal.

- Remove all burrs completely from cut cross section of the pipe.
- Put the end of the pipe to downward direction in order to prevent drop of burrs into the pipe.

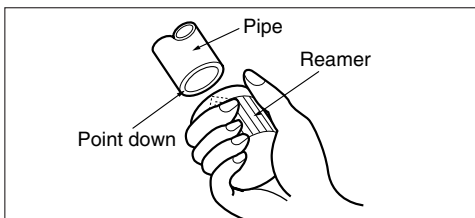

Step 3. Insert flare nut.

- Take out flare nuts attached at the indoor unit and the outdoor unit.
- Insert flare nuts into burr-removed pipe.
- If flaring work is finished, it is impossible to insert nuts into pipe.

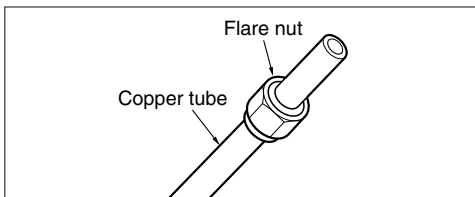

Step 4. Flaring work.

- Carry out flaring work using dedicated flaring tool for R-410A refrigerant as shown below.

Outside diameter		"A"
mm	inch	mm
6.35	1/4	1.1 ~ 1.3
9.52	3/8	1.5 ~ 1.7
12.7	1/2	1.6 ~ 1.8
15.88	5/8	1.6 ~ 1.8
19.05	3/4	1.9 ~ 2.1

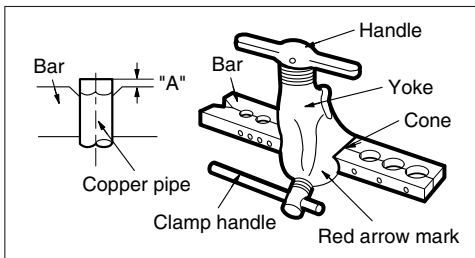

- Firmly hold copper tube in a bar(or die) as indicated dimension in the table above.

Step 5. Check

- Compare the flared work with right figure.
- If flare is seemed to be defective, cut off the flared section and do flaring work again.

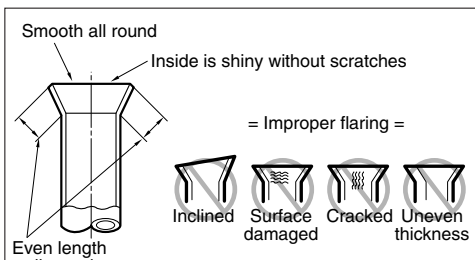

Connecting Pipe to Indoor Unit

Connecting pipe to the indoor unit is two steps. Read following directions carefully.

Step 1. Pre-tightening.

- Align the center of the pipes and sufficiently tighten the flare nut by hand.

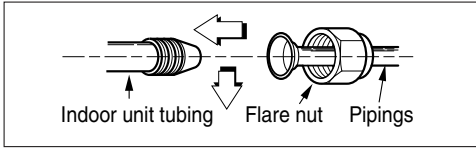

Step 2. Tightening.

- Tighten the flare nut with a wrench.
- Tightening torque is as following.

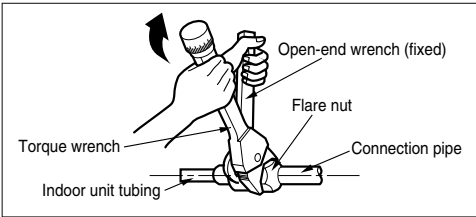

Outside diameter		Torque
mm	inch	kgf·m
6.35	1/4	1.8 ~ 2.5
9.52	3/8	3.4 ~ 4.2
12.7	1/2	5.5 ~ 6.6
15.88	5/8	6.6 ~ 8.2
19.05	3/4	9.9 ~ 12.1

Connecting Pipe to Outdoor Unit

(Product Heating Capacity : 9kW(U4 Chassis),12kW,14kW,16kW)

Connecting pipe to the outdoor unit is five steps including PCB setting.

Step 1. Determine direction of pipes.

- The pipes can be connectable in four directions
- The directions are expressed in below figure.

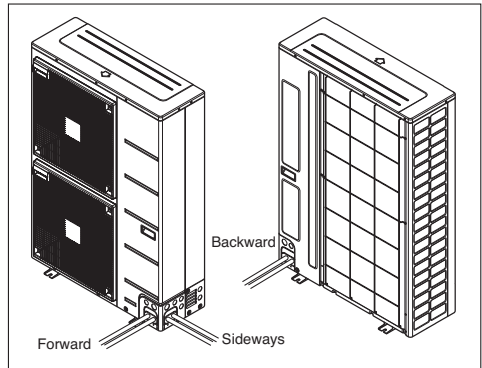
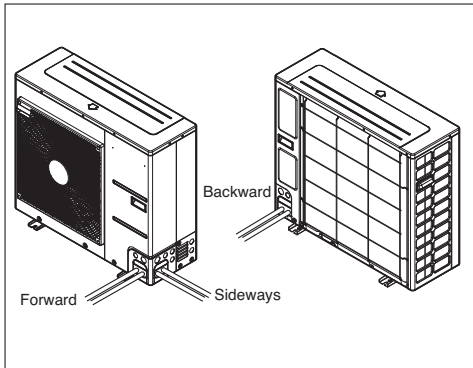

Step 2. Determine direction of pipes : in case of downward

Not Available

Step 3. Tightening

- Align the center of the pipes and sufficiently tighten the flare nut by hand.
- Tighten the flare nut with a wrench until the wrench clicks
- Tightening torque is as following.

Outside diameter		Torque kgf·m
mm	inch	
6.35	1/4	1.8 ~ 2.5
9.52	3/8	3.4 ~ 4.2
12.7	1/2	5.5 ~ 6.6
15.88	5/8	6.6 ~ 8.2
19.05	3/4	9.9 ~ 12.1

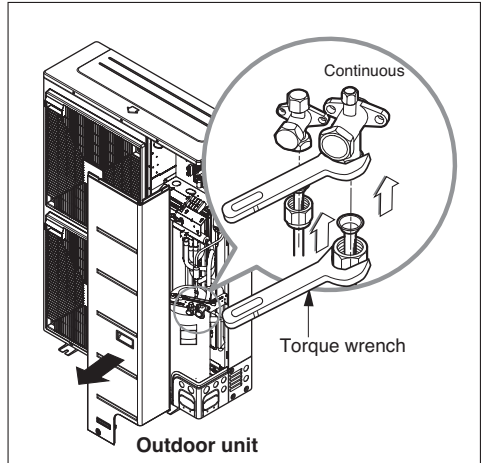

Step 4. Preventing entering of foreign objects

- Plug the pipe through-holes with putty or insulation material (procured locally) to fill up all gaps as shown in right figure.
- If insects or small animals enter the outdoor unit, it may cause a short circuit in the electrical box.
- Finally, form the pipes by wrapping the connecting portion of the indoor unit with insulation material and secure it with two kinds of vinyl tape. Ensuring thermal insulation is very important.

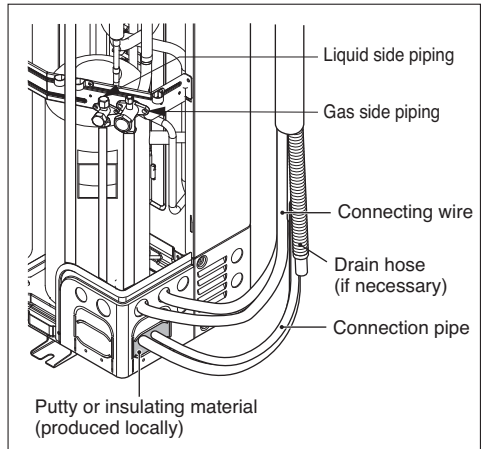

Step 5. PCB Setting when pipe is longer than 15m (if necessary)

- If pipe length is longer than 15m, the PCB setting should be performed according to following procedures.
 1. Open the control cover of outdoor unit
 2. Set to 'ON' for 4th switch of 5 pin DIP switch
 3. Close the cover and check the product operation

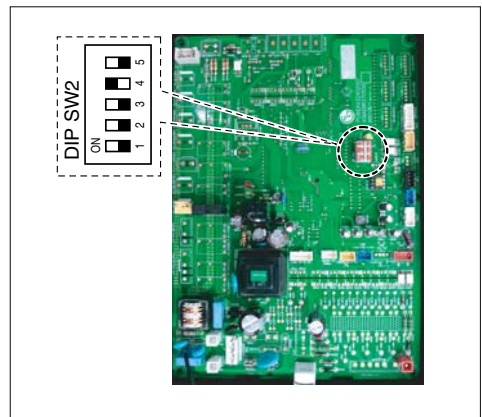

⚠ WARNING

Do not open the side panel and not set the DIP switch while product operation.

Connecting Pipe to Outdoor Unit (Product Heating Capacity : 9kW)

- Align the center of the pipings and sufficiently tighten the flare nut with fingers.
- Finally, tighten the flare nut with torque wrench until the wrench clicks.
 - When tightening the flare nut with torque wrench, ensure the direction for tightening follows the arrow on the wrench.

Outside diameter		Torque
mm	inch	kgf·m
Ø6.35	1/4	1.8~2.5
Ø9.52	3/8	3.4~4.2
Ø12.7	1/2	5.5~6.6
Ø15.88	5/8	6.3~8.2
Ø19.05	3/4	9.9~12.1

Align the center of the piping and sufficiently tighten the flare nut by hand.

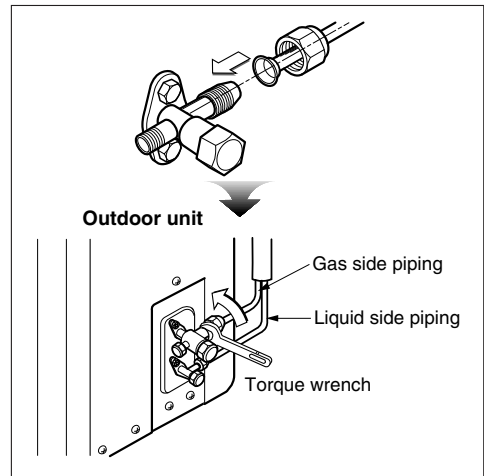

Electrical Wiring

Two kind of cables should be connected to the outdoor unit : One is 'Power cable', the other one is 'Connecting cable'. Power cable is a cable which is used to supply external electricity to the outdoor unit. This cable is generally connected between external power source (such as main electric power distribution panel of user's house) and the outdoor unit. Connecting cable is, on the other hand, used to connect between the outdoor unit and the indoor unit to supply electric power to the indoor unit and to establish the communication between the outdoor unit and the indoor unit.

Procedure for wiring to the outdoor unit is four steps. Before starting wiring, check if wire specification is suitable and read following directions and cautions VERY carefully.

Wire Specification

Power Cable Specification : The power cord connected to the outdoor unit should be complied with IEC 60245 or HD 22.4 S4(Rubber insulated cord, type 60245 IEC 66 or H07RN-F)



If the supply cord is damaged, it must be replaced by the manufacturer, its service agent or similarly qualified persons in order to avoid a hazard.

Terminal Specification of Power Cable and related Cautions :

Use round pressure terminals for connections to the power terminal block.

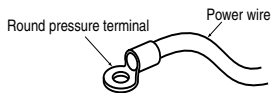

When none are available, follow the instructions below.

- Do not connect wiring of different thicknesses to the power terminal block. (Slack in the power wiring may cause abnormal heat.)
- When connecting wiring which is the same thickness, do as shown in the figure below.

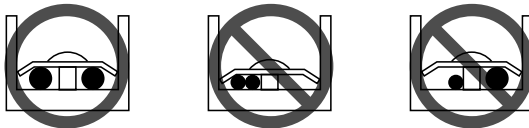

Connecting Cable Specification : The connecting cable, being used to connect the indoor unit and outdoor unit, should be complied with IEC 60335-1 standard (Rubber insulation, type H07RN-F approved by HAR or SAA).

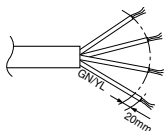

If the supply cable is damaged, it must be replaced by a special cable or assembly available from the manufacturer or its service agent.

Circuit Breaker Specification

- Select a power source that is capable of supplying the current required by the AWHP.
- Use a recognized circuit breaker between the power source and the unit.
- A disconnection device to adequately disconnect all supply lines must be fitted.
- Capacity of circuit breaker recommended.
- Separate main power supply and heater supply.

Model			Core Component Electrical Spec.									MOP & Circuit Breaker									
			Compressor			Electric Heater			Sanitary Tank Heater			For Heat Pump		For Electric Heater (without S/Heater)		For Electric Heater (with S/Heater)					
Indoor	Outdoor	Power Supply	RLA (A)	FLA (A)	Capacity (kW)	Power Supply	RLA (A)	Capacity (kW)	Power Supply	FLA (A)	MOP (A)	Circuit Breaker(A)	MOP (A)	Circuit Breaker(A)	MOP (A)	Circuit Breaker(A)					
AHNW096A0	AHUW096A0	220-240V 50Hz	9.7	15	2+2	1Ø 230V	8.3	3	1Ø 230V	12.5	23.9	20	27	30	45	40					
AHNW09604A1	AHUW096A1		1~	17.0	25		3+3				12.5	12.5	12.5	40.3	40	41	40	53	50	50	
AHNW126A0	AHUW126A0		1~	17.0	27																
AHNW146A0	AHUW146A0		1~	17.0	27																
AHNW166A0	AHUW166A0		1~	9.7	15		2+2+2				3Ø 220V	15.8	3	1Ø 230V	12.5	23.9	20	37	30	49	40
AHNW09606A0	AHUW096AN		1~	22	20		3Ø 400V				8.7										
AHNW09806A0	AHUW09806A0		1~	22	20		3Ø 400V				8.7										
AHNW16606A1	AHUW16606A1		3~	3+3	1Ø 230V		12.5														
AHNW16A06A1	AHUW168A1		3~	3+3	1Ø 230V		15.8														
AHNW16806A1	AHUW16806A1		3~	2+2+2	3Ø 400V		8.7														
AHNW16606A1	AHUW148A1	3~	3+3	1Ø 230V	12.5																
AHNW16A06A1	AHUW148A1	3~	3+3	1Ø 230V	15.8																
AHNW16806A1	AHUW148A1	3~	2+2+2	3Ø 400V	8.7																
AHNW16606A1	AHUW128A1	3~	3+3	1Ø 230V	12.5																
AHNW16606A1	AHUW128A1	3~	3+3	1Ø 230V	15.8																
AHNW16806A1	AHUW128A1	3~	2+2+2	3Ø 400V	8.7																
AHNW16606A1	AHUW126A1	1~	25	3+3	1Ø 230V	12.5	12.5	3	1Ø 230V	12.5	40.3	40	41	40	53	50					
AHNW16606A1	AHUW146A1	220-240V	17.0														27				
AHNW16606A1	AHUW166A1	50Hz	27														27				
AHNW09604A1	AHUW096A2	220-240V 50Hz	9.7	15	2+2	1Ø 230V	8.3	3	1Ø 230V	12.5	23.9	20	27	30	45	40					
AHNW16606A1	AHUW126A2	220-240V 50Hz	14.5	29	3+3	1Ø 230V	12.5														
AHNW16A06A1	AHUW126A2	220-240V 50Hz			2+2+2	3Ø 220V	15.8														
AHNW16806A1	AHUW146A2	220-240V 50Hz			3+3	1Ø 230V	12.5														
AHNW16606A1	AHUW146A2	220-240V 50Hz	16.9	29	2+2+2	3Ø 220V	15.8														
AHNW16A06A1	AHUW146A2	220-240V 50Hz			3+3	1Ø 230V	12.5														
AHNW16806A1	AHUW146A2	220-240V 50Hz			2+2+2	3Ø 400V	8.7														

Notes:

- MCA / MOP
 $MCA = (1.25 \times Load1) + Load2 + Load3$
 $MOP = (2.25 \times Load1) + Load2 + Load3$
 - Load1 : Rated running current of largest motor (compressor or other motor)
 - Load2 : sum of current for all other motors
 - Load3 : any other load rated 1.0A or more
- Select wire spec. based on the MCA
- Recommended circuit breaker is ELCB (Earth Leakage Circuit breaker)

4. RLA is measured during each individual compressor test condition.

MCA : Minimum Circuit Amperes (A)
 MOP : Maximum rating Over current Protective device
 RLA : Rated Load Amperes (A)
 FLA : Full Load Amperes (A)
 S/Heater: Sanitary Water Tan Heater

Wiring Procedure for Power Cable and Connecting Cable

- Step 1.** : Disassemble the side panel from the outdoor unit by loosening screws.
- Step 2.** : Connect Power cable to Main Power Terminal and Connecting cable to Control Terminal, respectively.
 See below figure for detailed information. When connecting earth cable, the diameter of cable should be bigger than 1.6mm² to secure safety. The earth cable is connected to the terminal block where earth symbol (⊕) is marked.
- Step 3.** : Use cable clamps (or cord clamps) to prevent unintended move of Power cable and Connecting cable.
- Step 4.** : Reassemble the side panel to the outdoor unit by fastening screws.

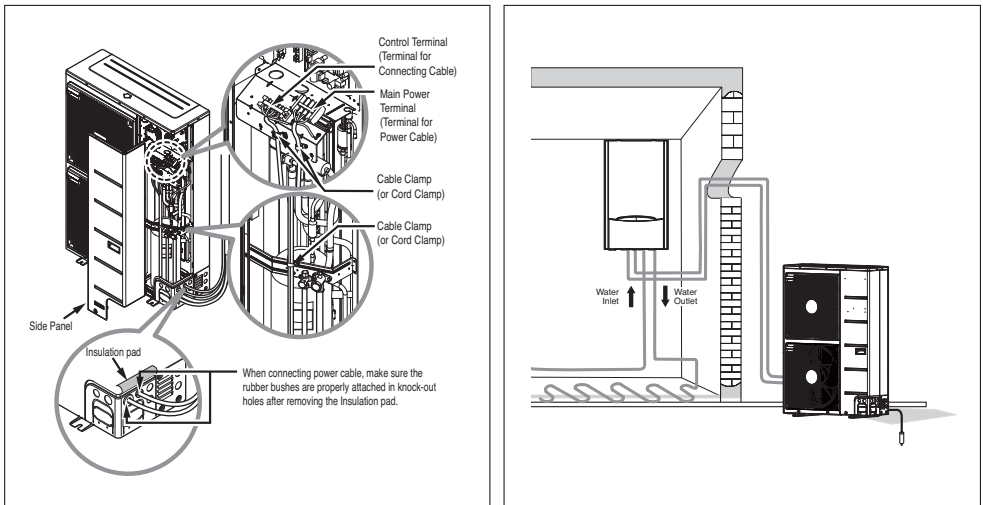

⚠ CAUTION

After checking and confirming following conditions, start wiring work.

1. Secure dedicated power source for the Air-to-Water heat pump. The wiring diagram (attached inside the control box of the indoor unit) is presenting related information.
2. Provide a circuit breaker switch between power source and the outdoor unit.
3. Although it is very rare case, sometimes the screws used to fasten internal wires can be loosen due to the vibration while product transportation. Check these screws and make it sure if they are all fastened tightly. If not tightened, burn-out of the wire can be occurred.
4. Check the specification of power source such as phase, voltage, frequency, etc.
5. Confirm that electrical capacity is sufficient.
6. Be sure that the starting voltage is maintained at more than 90 percent of the rated voltage marked on the name plate.
7. Confirm that the cable thickness is as specified in the power sources specification. (Particularly note the relation between cable length and thickness.)
8. Provide an ELB(electric leakage breaker) when the installation place is wet or moist.
9. The following troubles would be caused by abnormal voltage supply such as sudden voltage increasing or voltage drop-down.
 - Chattering of a magnetic switch (frequent on and off operation)
 - Physical damage of parts where magnetic switch is contacted
 - Break of fuse
 - Malfunction of overload protection parts or related control algorithms.
 - Failure of compressor start up
10. Ground wire to ground outdoor unit to prevent electrical shock.

Finalizing

After pipes are connected and electric cables are wired, pipe forming and some tests are remained. Especially, careful attention is required while proceeding leakage test because the leakage of the refrigerant effects degrade of performance directly. Also, it is very hard to find leaked point after all installation procedures are finished.

Pipe Forming

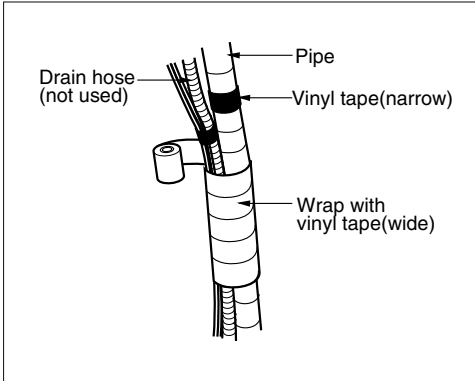

Do pipe forming by wrapping the connecting cable and refrigerant pipe (between the indoor unit and outdoor unit) with thermal insulation material and secure it with two kinds of vinyl tape.

1. Tape the refrigerant pipe, power cable and connecting cable from down to up.
2. Secure the taped pipe is along with the exterior wall. Form a trap to prevent water entering the room and electrical part.
3. Fix the taped pipe onto the wall by saddle or equivalent.

Taping Procedure

1. Tape the pipes, connecting cable and power cable from down to up. If taping direction is up to down, rain drop may be sinking into the pipes or cables.
2. Secure the taped pipe along the exterior wall using saddle or equivalent.
3. Trap is required to prevent water from entering into electrical parts.

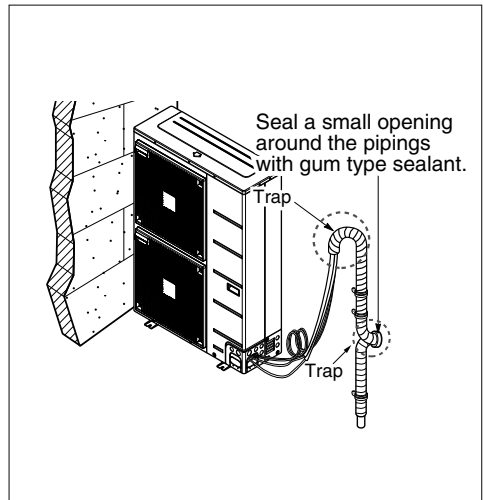
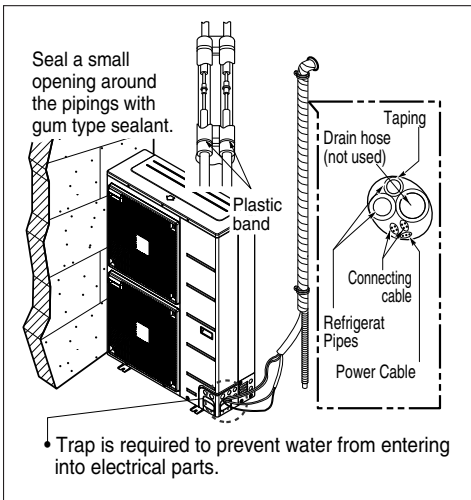

Leakage test and Evacuation

Air and moisture remaining in the refrigerant system have undesirable effects as indicated below.

1. Pressure in the system rises.
2. Operating current rises.
3. Cooling(or heating) efficiency drops.
4. Moisture in the refrigerant circuit may freeze and block capillary tubing.
5. Water may lead to corrosion of parts in the refrigeration system.

Therefore, the indoor/outdoor unit and connecting tube must be checked for leak tight, and vacuumed to remove incondensable gas and moisture in the system.

Preparation

- Check that each tube(both liquid and gas side tubes) between the indoor and outdoor units have been properly connected and all wiring for the test run has been completed. Remove the service valve caps from both the gas and the liquid side on the outdoor unit. Check that both the liquid and the gas side service valves on the outdoor unit are kept closed at this stage.

Leakage test

- Connect the manifold valve(with pressure gauges) and dry nitrogen gas cylinder to this service port with charge hoses.

⚠ CAUTION

Be sure to use a manifold valve for leakage test.

If it is not available, use a stop valve for this purpose. The "Hi" knob of the manifold valve must always be kept close.

- Pressurize the system to no more than 3.0 Mpa with dry nitrogen gas and close the cylinder valve when the gauge reading reached 3.0 Mpa Next, test for leaks with liquid soap.

⚠ CAUTION

To avoid nitrogen entering the refrigerant system in a liquid state, the top of the cylinder must be higher than its bottom when you pressurize the system. Usually, the cylinder is used in a vertical standing position.

1. Do a leakage test of all joints of the tubing(both indoor and outdoor) and both gas and liquid side service valves. Bubbles indicate a leak. Be sure to wipe off the soap with a clean cloth.

2. After the system is found to be free of leaks, relieve the nitrogen pressure by loosening the charge hose connector at the nitrogen cylinder. When the system pressure is reduced to normal, disconnect the hose from the cylinder.

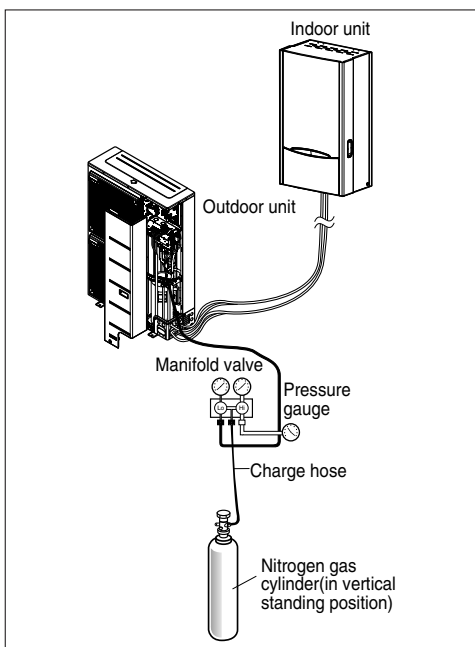

Evacuation

1. Connect the charge hose end described in the preceding steps to the vacuum pump to evacuate the tubing and indoor unit.
Confirm the "Lo and Hi" knob of the manifold valve is open. Then, run the vacuum pump.
The operation time for evacuation varies with tubing length and capacity of the pump. The following table shows the time required for evacuation.

Required time for evacuation when 30 gal/h vacuum pump is used	
If tubing length is less than 10 m(33 ft)	If tubing length is longer than 10 m(33 ft)
30 min. or more	60 min. or more
0.5 torr or less	

2. When the desired vacuum is reached, close the "Lo and Hi" knob of the manifold valve and stop the vacuum pump.

Finishing the job

1. With a service valve wrench, turn the valve stem of liquid side valve counter-clockwise to fully open the valve.
2. Turn the valve stem of gas side valve counter-clockwise to fully open the valve.
3. Loosen the charge hose connected to the gas side service port slightly to release the pressure, then remove the hose.
4. Replace the flare nut and its bonnet on the gas side service port and fasten the flare nut securely with an adjustable wrench. This process is very important to prevent leakage from the system.
5. Replace the valve caps at both gas and liquid side service valves and fasten them tight.
This completes air purging with a vacuum pump.
The air conditioner is now ready to test run.

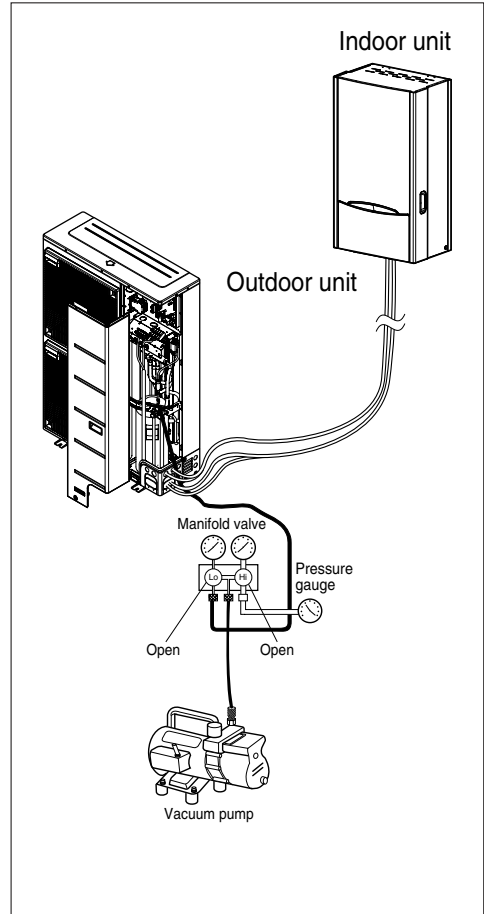

6. Piping and Wiring for Indoor Unit

Procedures about water piping and electric wiring at the indoor unit are described in this chapter. Water piping and water circuit connection, water charging, pipe insulations will be shown for water piping procedures. For wiring, terminal block connection, connecting with the outdoor unit, electric heater wiring will be introduced. Accessories connection, such as sanitary water tank, thermostat, 3way or 2way valves, etc will be dealt in separated chapter.

Water Piping and Water Circuit Connection

General Considerations

Followings are should be considered before beginning water circuit connection.

- Service space should be secured.
- Water pipes and connections should be cleaned using water.
- Space for installing external water pump should be provided if internal water pump capacity is not enough for installation field.
- Never connect electric power while proceeding water charging.

Water Piping and Water Circuit Connection

Definition of terms are as follow :

- Water piping : Installing pipes where water is flowing inside the pipe.
- Water circuit connecting : Making connection between the product and water pipes or between pipes and pipes. Connecting valves or elbows are, for example, in this category.

Configuration of water circuit is shown in Chapter 2. All connections should be complied with presented diagram.

While installing water pipes, followings should be considered :

- While inserting or putting water pipes, close the end of the pipe with pipe cap to avoid dust entering.
- When cutting or welding the pipe, always be careful that inner section of the pipe should not be defective. For example, no weldments or no burrs are found inside the pipe.
- Drain piping should be provided in case of water discharge by the operation of the safety valve. This situation can be happened when the internal pressure is over 3.0 bar and water inside the indoor unit will be discharged to drain hose.

While connecting water pipes, followings should be considered.

- Pipe fittings (e.g. L-shape elbow, T-shape tee, diameter reducer, etc) should be tightened strongly to be free from water leakage.
- Connected sections should be leakage-proof treatment by applying tefron tape, rubber bushing, sealant solution, etc.
- Appropriate tools and tooling methods should be applied to prevent mechanical breakage of the connections.
- Operation time of flow control valve(e.g. 3way valve or 2way valve) should be less than 90 seconds.
- Drain hose should be connected with drain piping.

WARNING

Installing shut-off valve

- While assembling two shut-off valves, that are found inside 'AWHP Installation Kit (AET69364401)', pop sound will be heard when valve is open or close by rotating handles. It is normal condition because the sound is due to leakage of charged nitrogen gas inside the valve. The nitrogen gas is applied to secure quality assurance.
- Before starting water charging, these two shut-off valves should be assembled with water inlet and outlet pipe of the indoor unit.

Water condensation on the floor

While cooling operation, it is very important to keep leaving water temperature higher than 16°C. Otherwise, dew condensation can be occurred on the floor.

If floor is in humid environment, do not set leaving water temperature below 18 °C.

Water condensation on the radiator

While cooling operation, cold water may not flow to the radiator. If cold water enters to the radiator, dew generation on the surface of the radiator can be occurred.

Drainage treatment

While cooling operation, condensed dew can drop down to the bottom of the indoor unit. In this case, prepare drainage treatment (for example, vessel to contain condensed dew) to avoid water drop.

Water Charging

For water charging, please follow below procedures.

Step 1. Open all valves of whole water circuit. Supplied water should be charged not only inside the indoor unit, but also in the under floor water circuit, sanitary water tank circuit, FCU water circuit, and any other water circuits controlled by the product.

Step 2. Connect supply water into drain valve and fill valve located at the side of the shut-off valve.

CAUTION

No water-leakage permitted at the drain and fill valve. Leakage-proof treatment which is described in previous section should be applied.

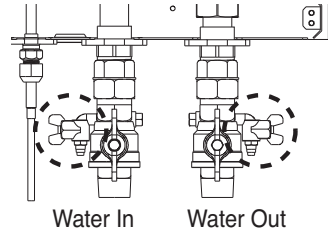

Step 3. Start to supply water. While supplying water, following should be kept.

- Pressure of supplying water should be 2.0 bar approximately.
- For supplying water pressure, time to be taken from 0 bar to 2.0 bar should be more than 1 minute. Sudden water supply can yield water drain through safety valve.
- Fully open the cap of air vent to assure air purging. If air is exist inside the water circuit, then performance degrade, noise at the water pipe, mechanical damage at the surface of electric heater coil.

Step 4. Stop water supplying when the pressure gage located in front of the control panel indicates 2.0 bar.

Step 5. Close drain valve and fill valve. Then wait for 20~30 seconds to observe water pressure being stabilized.

Step 6. If following conditions are satisfactory, then go to step 7(pipe insulation). Otherwise, go to step 3.

- Pressure gage indicates 2.0 bar. Note that sometimes pressure in decreased after step 5 due to water charging inside expansion vessel.
- No air purging sound is heard or no water drop are popping out from air vent.

Pipe Insulation

Purpose of water pipe insulation is :

- To prevent heat loss to external environment
- To prevent dew generation on the surface of the pipe in cooling operation

Electrical Wiring

General Consideration

Followings are should be considered before beginning indoor unit wiring.

- Field-supplied electrical components such as power switches, circuit breakers, wires, terminal boxes, etc should be properly chosen with compliance with national electrical legislation or regulation.
- Make it sure that supplied electricity is enough to operate the product including outdoor unit, electric heater, water tank heater, etc. The capacity of fuse also selected according to the power consumption.
- The main electricity supply should be dedicated line. Sharing main electricity supply with other devices such as washing machine or vacuum cleaner is not permitted.

⚠ CAUTION

- Before starting wiring job, the main electricity supply should be turned off until wiring is completed.
- When adjusting or changing wiring, the main electricity supply should be turned off and ground wire should be connected securely.
- Installation place should be free from the attack of wild animal. For example, mice's wire attacking or frog's entering into the indoor unit may cause critical electrical accident.
- All power connections should be protected from dew condensation by thermal insulation.
- All electrical wiring should comply with national or local electrical legislation or regulation.
- The ground should be connected exactly. Do not earth the product to the copper pipe, steel fence at the veranda, city water outlet pipe, or any other conductivity materials.
- Fix all cable using cord clamp tightly. (When cable is not fixed with cord clamp, use additionally supplied cable ties.)

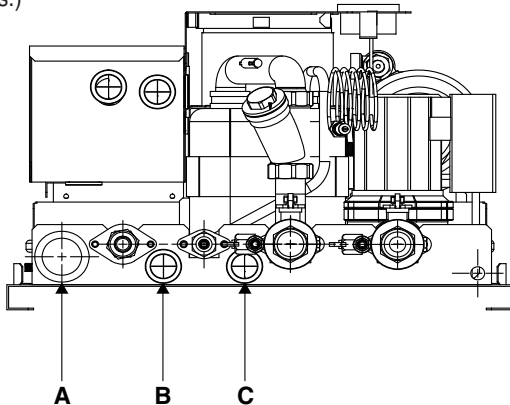

Hole A, B : for AC line (wire which is connected to the terminal block of the control box)
 Hole C : for DC line (wire which is connected to the PCB of the control box)

Terminal Block Information (1Ø Electric Heater)

Symbols used below pictures are as follows :

- L, L1, L2 : Live (230V AC)
- N : Neutral (230V AC)
- BR : Brown , WH : White , BL : Blue , BK : Black

Terminal Block 1

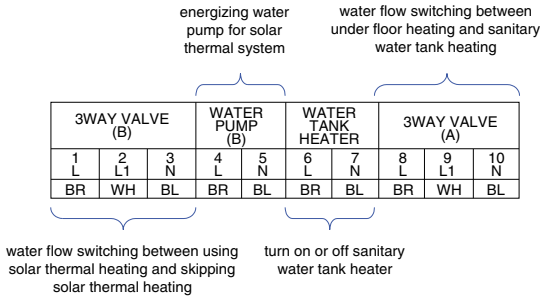

Terminal Block 2

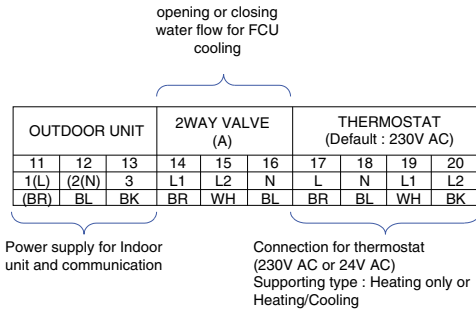

Terminal Block 3

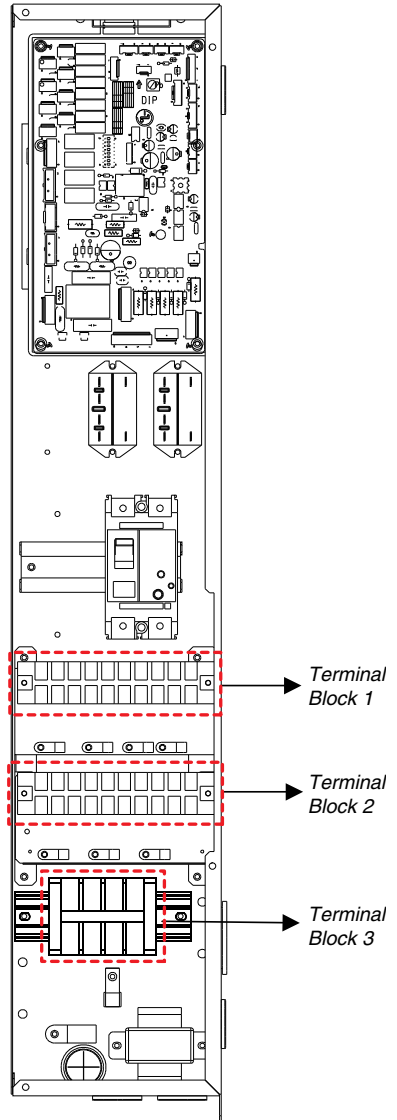
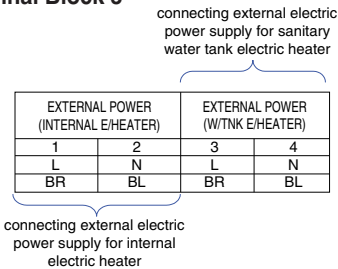

Terminal Block Information (3Ø Electric Heater)

Symbols used below pictures are as follows :

- L, L1, L2 : Live (230V AC)
- N : Neutral (230V AC)
- BR : Brown , WH : White , BL : Blue , BK : Black

Terminal Block 1

energizing water pump for solar thermal system

water flow switching between under floor heating and sanitary water tank heating

3WAY VALVE (B)			WATER PUMP (B)		WATER TANK HEATER		3WAY VALVE (A)		
1	2	3	4	5	6	7	8	9	10
L	L1	N	L	N	L	N	L	L1	N
BR	WH	BL	BR	BL	BR	BL	BR	WH	BL

water flow switching between using solar thermal heating and skipping solar thermal heating

turn on or off sanitary water tank heater

Terminal Block 2

opening or closing water flow for FCU cooling

OUTDOOR UNIT			2WAY VALVE (A)			THERMOSTAT (Default : 230V AC)			
11	12	13	14	15	16	17	18	19	20
1(L)	(2(N)	3	L1	L2	N	L	N	L1	L2
(BR)	BL	BK	BR	WH	BL	BR	BL	WH	BK

Power supply for Indoor unit and communication

Connection for thermostat (230V AC or 24V AC)
Supporting type : Heating only or Heating/Cooling

Terminal Block 3

connecting external electric power supply for sanitary water tank electric heater

EXTERNAL POWER (W/TNK E/HEATER)		EXTERNAL POWER (INTERNAL E/HEATER)		
1	2	3	4	5
L	N	R	S	T
BR	BL	BR	BK	GY

connecting external electric power supply for internal electric heater

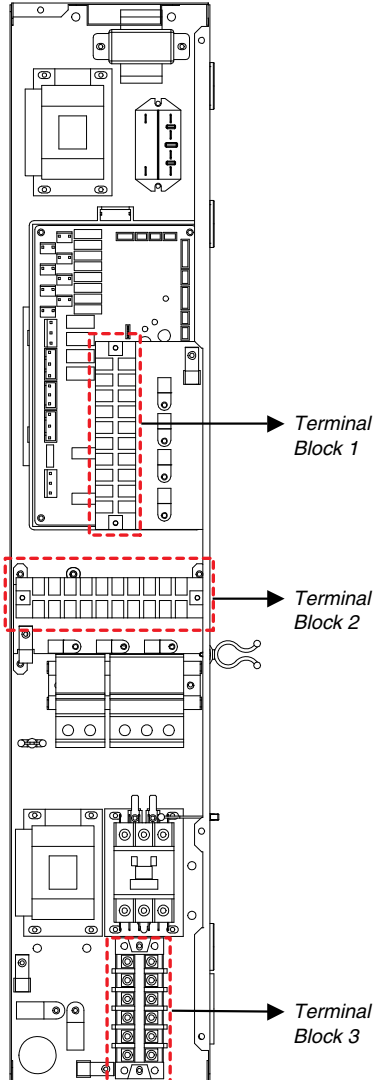

⚠ CAUTION

You should separate the communication wiring, in case of communication wiring length is over 40M

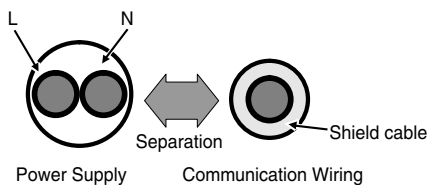

Connecting with Outdoor Unit

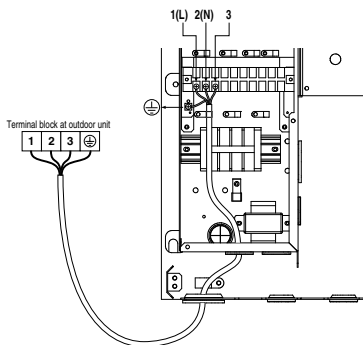

1Ø Electric Heater

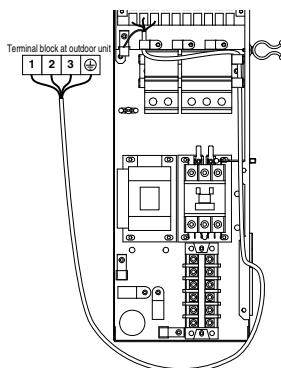

3Ø Electric Heater

Electric Heater Wiring

⚠ CAUTION

Power Cable Specification : The power cord connected to the outdoor unit should be complied with IEC 60245 or HD 22.4 S4(Rubber insulated cord, type 60245 IEC 66 or H07RN-F)

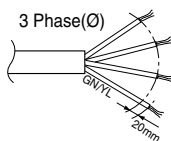
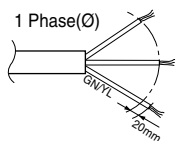

If the supply cord is damaged, it must be replaced by the manufacturer, its service agent or similarly qualified persons in order to avoid a hazard.

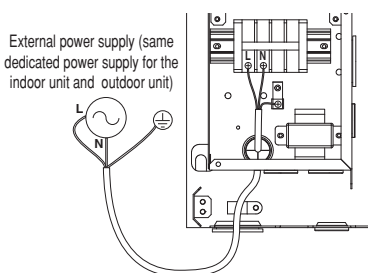

1Ø Electric Heater

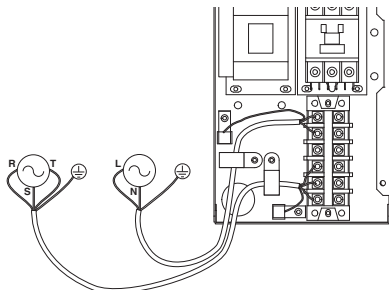

3Ø Electric Heater

7. Accessories Installation

THERMAV can interface to various accessories to extend its functionality and to improve user convenience. In this chapter, specifications about supported 3rd party accessories and how to connect to **THERMAV** is introduced.

It is noted that this chapter only deal with 3rd party accessories. For accessories supported by LG Electronics, please refer to installation manual of each accessories.

Before Installation

⚠ WARNING

Followings should be kept before installation

- Main power must be turned off during installing 3rd party accessories.
- 3rd party accessories should be comply with supported specification.
- Proper tools should be chosen for installation.
- Never do installation with wet hands.

Thermostat

Thermostat is generally used to control the product by air temperature. When thermostat is connected to the product, the product operation is controlled by the thermostat.

General Information

THERMAV supports following thermostats.

Type	Power	Operating Mode	Supported
Mechanical (1)	230 V AC	Heating Only (3)	Yes
		Heating / Cooling (4)	Yes
	24 V AC	Heating Only (3)	Yes
		Heating / Cooling (4)	Yes
Electrical (2)	230 V AC	Heating Only (3)	Yes
		Heating / Cooling (4)	Yes
	24 V AC	Heating Only (3)	Yes
		Heating / Cooling (4)	Yes

(1) : There is no electric circuit inside the thermostat and electric power supply to the thermostat is not required.

(2) : Electric circuit such as display, LED, buzzer, etc is included in the thermostat and electric power supply is required.

(3) : Thermostat generates 'Heating ON or Heating OFF' signal according to user's heating target temperature.

(4) : Thermostat generates both 'Heating ON or Heating OFF' and 'Cooling ON or Cooling OFF' signal according to user's heating and cooling target temperature.

⚠ CAUTION

Choosing Heating / Cooling Thermostat

- Heating / Cooling Thermostat must have 'Mode Selection' feature to distinguish operation mode.
- Heating / Cooling Thermostat must be able to assign heating target temperature and cooling target temperature differently.
- If above conditions are not kept, the product can not operation properly.
- Heating / Cooling Thermostat must send cooling or heating signal immediately when temperature condition is satisfied. No delay time while sending cooling or heating signal is permitted.

How to Wire Thermostat

Follow below procedures Step 1 ~ Step 6.

Step 1. Uncover front cover of the indoor unit and open the control box.

Step 2. Identify the power specification of the thermostat. If it is 230V AC, go to Step 4. Otherwise, if it is 24V AC, go to step 3

Step 3. Find thermostat connecting cable A and C. Disconnect cable A and C, then connect cable B and C.

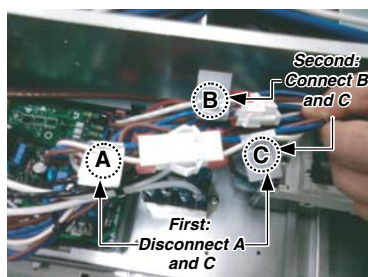

10 Electric Heater

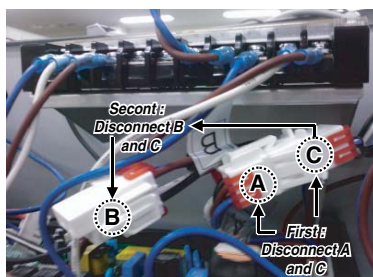

30 Electric Heater

Step 4. If it is Heating Only Thermostat, go to step 5. Otherwise, if it is Heating / Cooling Thermostat, go to step 6.

Step 5. Find terminal block and connect wire as below. After connecting, go to step 6.

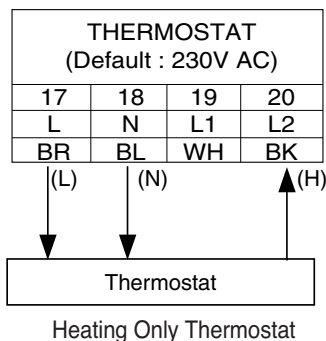

⚠ WARNING

Mechanical type Thermostat

Do not connect wire (N) as mechanical type thermostat does not require electric power supply.

⚠ CAUTION

Do not connect external electric loads

Wire (L) and (N) should be used only for operation Electric type thermostat. Never connect external electric loads such as valves, fan coil units, etc. If connected, PCB of the indoor unit can be seriously damaged.

(L) : Live signal from PCB to Thermostat

(N) : Neutral signal from PCB to Thermostat

(H) : Heating signal from Thermostat to PCB

Step 6. Find terminal block and connect wire as below.

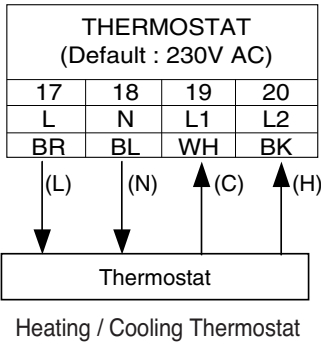

⚠ WARNING

Mechanical type Thermostat

Do not connect wire (N) as mechanical type thermostat does not require electric power supply.

⚠ CAUTION

Do not connect external electric loads

Wire (L) and (N) should be used only for operation Electric type thermostat.

Never connect external electric loads such as valves, fan coil units, etc. If connected, PCB of the indoor unit can be seriously damaged.

(L) : Live signal from PCB to Thermostat

(N) : Neutral signal from PCB to Thermostat

(C) : Cooling signal from Thermostat to PCB

(H) : Heating signal from Thermostat to PCB

Final Check

- DIP switch setting :
Set DIP switch No. 8 to 'ON'. Otherwise, the product can not recognize the thermostat.
- Control Panel :
- 'Thermostat' icon is displayed on the control panel.
- Button input is prohibited.

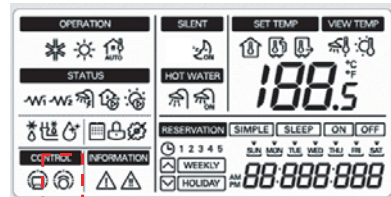

Thermostat Icon

⚠ NOTICE

Thermostat Operation with Control Panel

Following features are permitted when thermostat is installed :

- SET TEMP button
- VIEW TEMP button
- Temperature adjust button (*)
- Sanitary water heating Enable / Disable
- Silent operation On / Off

(*) : Adjusted temperature is only used to control electric heater on / off condition.

The product does not turn on / off according to the setting temperature at the control panel. It turns on / off according to the thermostat signal.

Following features are NOT permitted when thermostat is installed :

- Operating mode (cooling/ heating/ weather-dependent) selection
- Time scheduling
- Operation On / Off

Sanitary Water Tank and Sanitary Water Tank Kit/Solar Thermal Kit

To establish sanitary water circuit, 3way valve and sanitary water tank kit is required. If solar thermal system is pre-installed at the installation field, solar thermal kit is required to interface solar thermal system – to – sanitary water tank – to – **THERMAV**.

General Information

THERMAV supports following 3way valve.

Type	Power	Operating Mode	Supported
SPDT 3-wire (1)	230V AC	Selecting "Flow A" between "Flow A" and "Flow B" (2)	Yes
		Selecting "Flow B" between "Flow A" and "Flow B" (3)	Yes

(1) : SPDT = Single Pole Double Throw. Three wires consist of Live1 (for selecting Flow A), Live 2 (for selecting Flow B), and Neutral (for common).

(2) : 'Flow A' means water flow from the indoor unit to under floor water circuit.

(3) : 'Flow B' means water flow from the indoor unit to sanitary water tank.

How to Install Sanitary Water Tank

For more detail information about installing sanitary water tank, please refer installation manual provided with sanitary water tank.

PHS02060310(LGRTV200E) / PHS03060310(LGRTV300E)

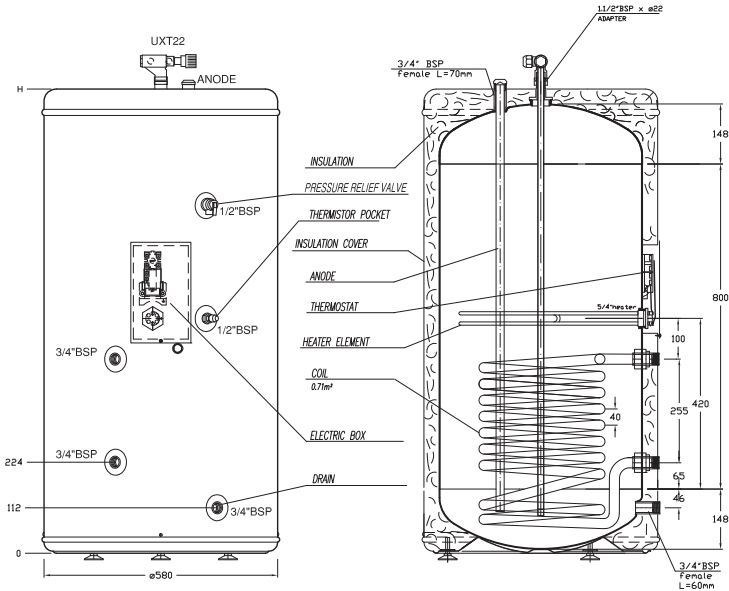

PHS02060320(LGRTV200VE) / PHS03060320(LGRTV300VE)

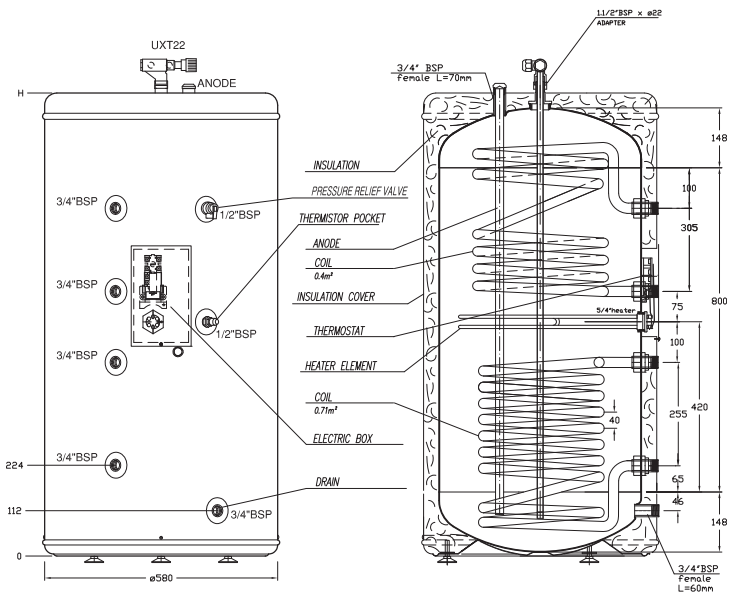

(unit : mm)

How to Install Sanitary Water Tank Kit

Follow below procedures Step 1 ~ Step 6.

Step 1. Find a relay contactor and ELB(MCCB) in the kit. Bolt them into control box. (symbol Ⓐ at picture)

Step 2. Connect 'CN_B/HEAT(A)' (White Connector) of the indoor unit PCB with relay contact using included cable (symbol Ⓑ at the picture). Connect relay contactor port no. 0 and 1.

Step 3. Connect relay contactor port no. 2 and 6 with ELB(MCCB) port no. 2 and 4. (symbol Ⓒ at the picture).

⚠ CAUTION

Check Polarity

- Connect relay contact port no. 2 to ELB(MCCB) port no. 2
- Connect relay contact port no. 6 to ELB(MCCB) port no. 4

Step 4. Connect relay contactor port no. 4 and 8 with terminal block 1 port 6 and 7. (symbol Ⓓ at the picture).

Check Polarity

- Connect relay contact port no. 4 to terminal block 1 port 6
- Connect relay contact port no. 8 to terminal block 1 port 7

Step 5. 1Ø Electric Heater

→ Connect ELB(MCCB) port no. 1 and 3 with terminal block 3 port 3 and 4. (symbol Ⓔ at the picture).

3Ø Electric Heater

→ Connect ELB(MCCB) port no. 1 and 3 with terminal block 3 port 1 and 2. (symbol Ⓔ at the picture).

Check Polarity

1Ø Electric Heater

- Connect ELB(MCCB) port no. 1 to terminal block 3 port 3
- Connect ELB(MCCB) port no. 3 to terminal block 3 port 4

3Ø Electric Heater

- Connect ELB(MCCB) port no. 1 to terminal block 3 port 1
- Connect ELB(MCCB) port no. 3 to terminal block 3 port 2

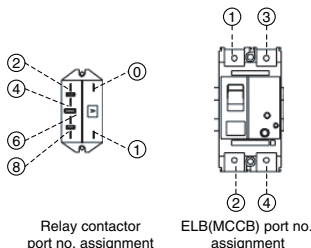

Note:

Some models are using MCCB instead of ELB

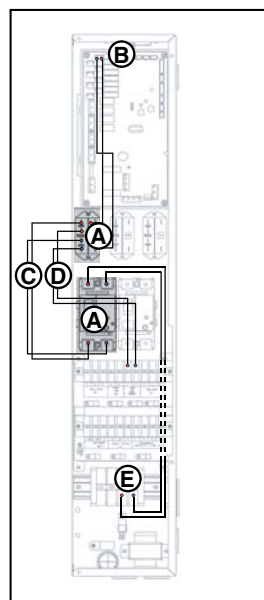

1Ø Electric Heater

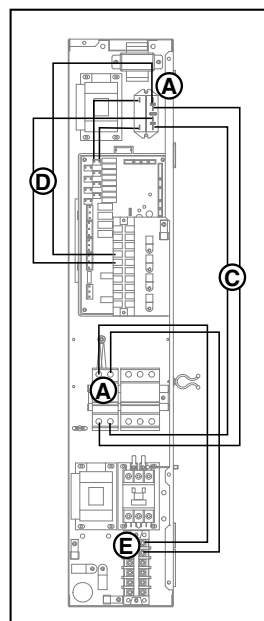

3Ø Electric Heater

Step 6. Find sanitary water tank sensor. Connect it to 'CN_TH4' (Red Connector) of the indoor unit PCB (symbol **A** at the picture). The sensor wire should be passed through holes for sensor (symbol **B** and **C** at the picture). The sensor should be mounted correctly to the sensor hole of sanitary water tank.

⚠ CAUTION

Sensor mounting

Insert sensor into sensor socket and bolt it tightly.

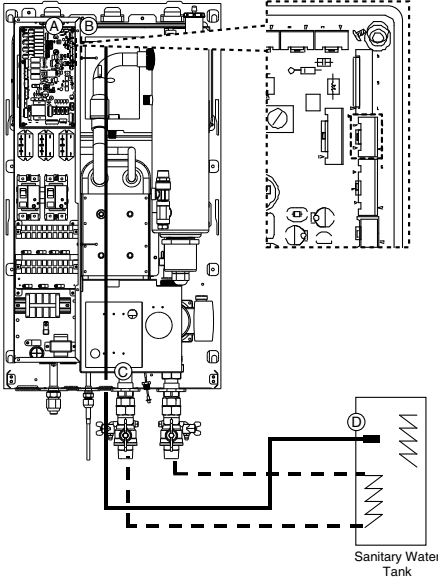

10 Electric Heater

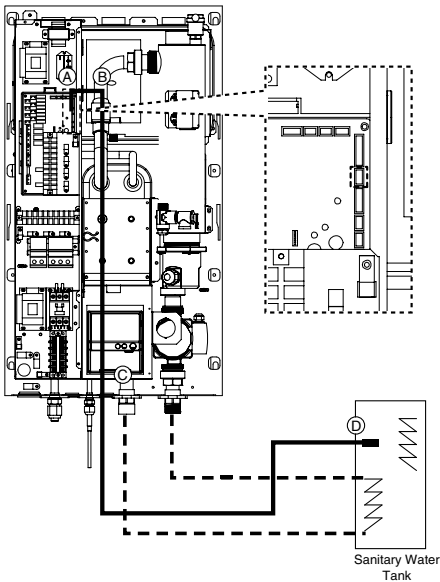

30 Electric Heater

How to Wire Sanitary Water Tank Heater

Step 1. Uncover heater cover of the sanitary water tank. It is located side of the tank.

Step 2. Find terminal block and connect wires as below. Wires are field-supplied item.

(L) : Live signal from PCB to Heater

(N) : Neutral signal from PCB to Heater

⚠ WARNING

Wire specification

- Cross-sectional area of the wire should be 5mm².

Adjusting thermostat temperature

- To guarantee proper operation, it is recommended to set temperature of thermostat to maximum temperature (symbol at the picture).

1Ø Electric Heater

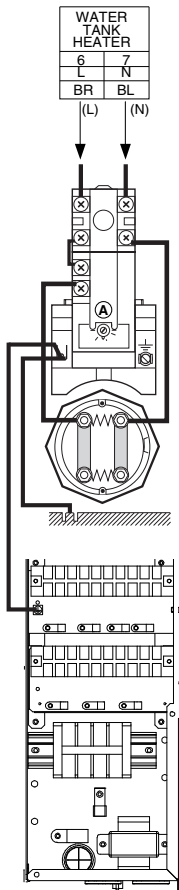

3Ø Electric Heater

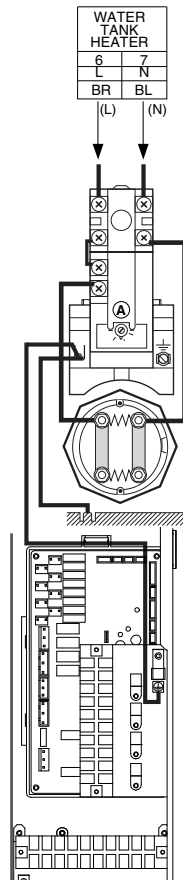

How to Install Solar Thermal Kit

- Step 1.** Check the diameter of pre-installed pipes. (symbol Ⓐ and Ⓑ)
- Step 2.** If the diameter of pre-installed pipes is different from diameter of solar thermal kit, it is necessary to reduce or extend of pipe's diameter.
- Step 3.** After Step 2., connect the pipe and solar thermal kit.
- Step 4.** Connect solar thermal sensor to 'CN_TH4'(Red connector) of the indoor unit PCB.
If the sanitary tank sensor is connected, disconnect the sensor from PCB first.

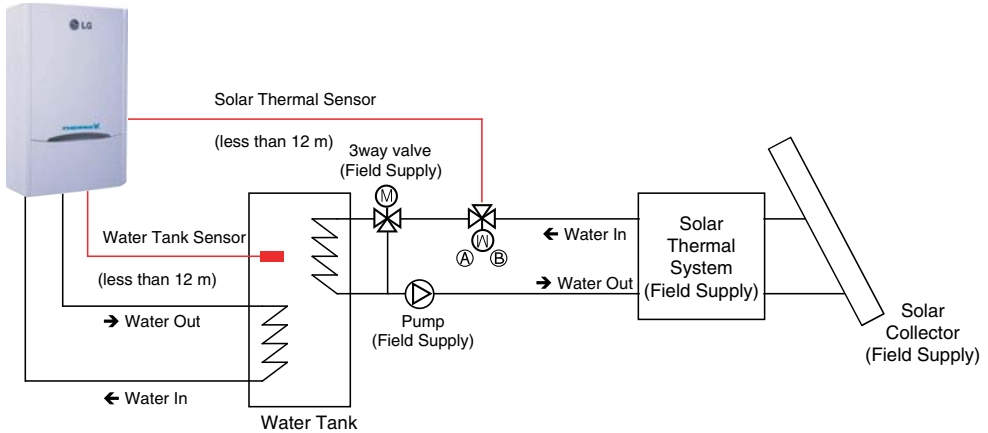

Dry Contact

LG Dry Contact is a solution for automatic control of air conditioning system at the owner's behest. In simple words, it's a switch which can be used to turn the unit On/Off after getting the signal from external sources like key-in lock, door or window switch etc specially used in Hotel rooms.

How to Install Dry Contact

- For more information about installing Dry Contact, Please refer installation manual provided with Dry Contact.
- For system set-up, please read chapter 8.(Especially function code No.6)

Remote Temperature Sensor

Remote temperature sensor can be installed any place a user wants to detect the temperature.

How to Install Remote Temperature Sensor

- For more information about installing Remote Temperature Sensor, Please refer installation manual provided with Remote Temperature Sensor.
- For system set-up, please read chapter 8.(Especially function code No.3)

3Way Valve

How to Wire 3Way Valve

Follow below procedures Step 1 ~ Step 2.

Step 1. Uncover front cover of the indoor unit and open the control box.

Step 2. Find terminal block and connect wire as below.

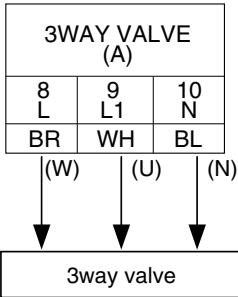

⚠ WARNING

- 3way valve should select water tank loop when electric power is supplied to wire (W) and wire (N).
- 3way valve should select under floor loop when electric power is supplied to wire (U) and wire (N).

(W) : Live signal (Water tank heating) from PCB to 3way valve

(U) : Live signal (Under floor heating) from PCB to 3way valve

(N) : Neutral signal from PCB to 3way valve

Final Check

- Flow direction :
 - Water should flow from water outlet of the indoor unit to sanitary tank water inlet when sanitary tank heating is selected.
 - To verify the flow direction, check temperature at the water outlet of the indoor unit and water inlet of sanitary water tank.
 - If correctly wired, these temperatures should be almost equivalent if thermal insulation of water pipe is well performed.
- Noise or water pipe vibration while 3way valve operation
 - Due to surging effect or cavitation effect, noise or water pipe vibration can be occurred while 3way valve is operating.
 - In that case, check followings :
 - Is water circuit (both under floor water loop and sanitary water tank loop) fully charged? If not, additional water charging is required.
 - Fast valve operation yields noise and vibration. Appropriated valve operating time is 60~90 seconds.

2Way Valve

2way valve is required to control water flow while cooling operation. Role of 2way valve is to cut off water flow into under floor loop in cooling mode when fan coil unit is equipped for cooling operation.

General Information

THERMAV supports following 2way valve.

Type	Power	Operating Mode	Supported
NO 2-wire (1)	230V AC	Closing water flow	Yes
		Opening water flow	Yes
NC 2-wire (2)	230V AC	Closing water flow	Yes
		Opening water flow	Yes

(1) : Normal Open type. When electric power is NOT supplied, the valve is open. (When electric power is supplied, the valve is closed.)

(2) : Normal Closed type. When electric power is NOT supplied, the valve is closed. (When electric power is supplied, the valve is open.)

How to Wire 2Way Valve

Follow below procedures Step 1 ~ Step 2.

Step 1. Uncover front cover of the indoor unit and open the control box.

Step 2. Find terminal block and connect wire as below.

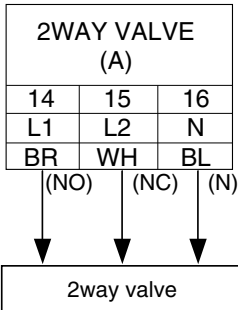

CAUTION

Dew Condensation

- Wrong wiring can yield dew condensation on the floor. If radiator is connected at the under floor water loop, dew condensation can be occurred on the surface of the radiator.

WARNING

Wiring

- Normal Open type should be connected to wire (NO) and wire (N) for valve closing in cooling mode.
- Normal Open type should be connected to wire (NO) and wire (N) for valve closing in cooling mode.

(NO) : Live signal (for Normal Open type) from PCB to 2way valve

(NC) : Live signal (for Normal Closed type) from PCB to 2way valve

(N) : Neutral signal from PCB to 2way valve

Final Check

- Flow direction :
 - Water should not flow into under floor loop in cooling mode.
 - To verify the flow direction, check temperature at the water inlet of the under floor loop.
 - If correctly wired, this temperatures should not be approached to 6°C in cooling mode.

8. System Set-Up

As **THERMAV** is designed to satisfy various installation environment, it is important to set up system correctly. If not configured correctly, improper operation or degrade of performance can be expected.

DIP Switch Setting

⚠ CAUTION







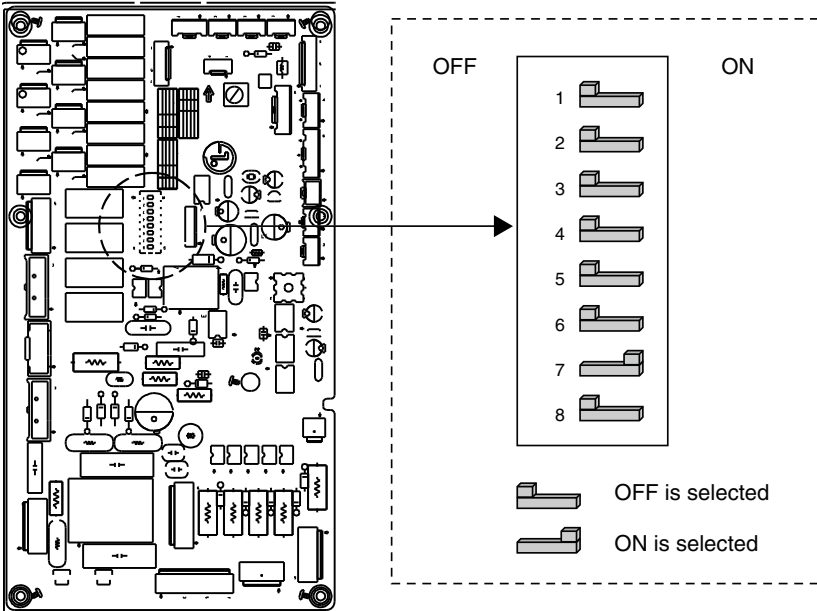





















Turn off electric power supply before setting DIP switch

- Whenever adjusting DIP switch, turn off electric power supply to avoid electric shock.

General Information



DIP Switch Information

Description	Setting	Default
Role when central controller is equipped	1  As Master	1 
	1  As Slave	
Accessory installation information	2  3  Indoor unit + Outdoor unit is installed	2  3 
	2  3  Indoor unit + Outdoor unit + Sanitary water tank is installed	
	2  3  Indoor unit + Outdoor unit + Sanitary water tank + Solar thermal system is installed	
Emergency operation Level	4  High temperature cycle	4 
	4  Low temperature cycle	
External water pump installation information	5  External water pump is NOT installed	5 
	5  External water pump is installed	
Selecting electric heater capacity	6  7  Step 2 capacity is used	6  7 
	6  7  Step 1 capacity is used	
	6  7  Electric heater is not used	
Thermostat installation information	8  Thermostat is NOT installed	8 
	8  Thermostat is installed	

! NOTICE

Emergency Operation

• Definition of terms

- **Trouble** : a problem which can stop system operation, and can be resumed temporarily under limited operation without certificated professional's assist.
- **Error** : problem which can stop system operation, and can be resumed ONLY after certificated professional's check.
- **Emergency mode** : temporary heating operation while system met Trouble.

• Objective of introducing 'Trouble'

- Not like airconditioning product, Air-to-Water heat pump is generally operation in whole winter season without any system stopping.
- If system found some problem, which is not critical to system operating for yielding heating energy, the system can temporarily continue in emergency mode operation with end user's decision.

• Classified Trouble





- Trouble is classified two levels according to the seriousness of the problem : Slight Trouble and Heavy trouble
- **Slight Trouble** : a problem is found inside the indoor unit. In most case, this trouble is concerned with sensor problems. The outdoor unit is operating under emergency mode operation condition which is configured by DIP switch No. 4 of the indoor unit PCB.
- **Heavy trouble** : a problem is found inside the outdoor unit. As the outdoor unit has problem, the emergency mode operation is performed by electric heater located in the indoor unit.
- **Option Trouble** : a problem is found for option operation such as water tank heating. In this trouble, the troubled option is assumed as if it is not installed at the system.

• Emergency operation level

- When system met trouble, it stops operation and wait for user's decision : Calling service center or starting emergency operation.
- To start emergency operation, user simply push ON / OFF button once more.
- Two different levels are prepared for emergency operation : High temperature cycle and low temperature cycle.
- In emergency operation mode, user can not adjust target temperature.

	DIP Switch	Target Leaving Water Temperature	Target Room Air Temperature	Target Sanitary Water Temperature
High temperature cycle	OFF	50°C	24°C	70°C
Low temperature cycle	ON	30°C	19°C	50°C

• **Following features are permitted in emergency operation :**





-  Operation On/Off
-  VIEW TEMP button(*)
-   Temperature adjust button (*)
-  Sanitary water heating Enable / Disable

(*) : Temperature measured by failed sensor is displayed as ‘ - -’.

(*) : Adjusted temperature is only used to control electric heater on / off condition.

The product does not turn on / off according to the setting temperature at the control panel. It turns on / off according to the thermostat signal.

• **Following features are NOT permitted in emergency operation :**

-  Operating mode (cooling/ heating/ weather-dependent) selection
-  Time scheduling
-  SET TEMP button
-  Silent operation On / Off

• **Duplicated trouble : Option trouble with Slight or Heavy trouble**

If option trouble is occurred with slight (or heavy) trouble at the same time, the system puts higher priority to slight (or heavy) trouble and operates as if slight (or heavy) trouble is occurred. Therefore, sometimes sanitary water heating can be impossible in emergency operation mode. When sanitary water is not warming up while emergency operation, please check if sanitary water sensor and related wiring are all Ok.

• **Emergency operation is not automatically restarted after main electricity power is reset.**

In normal condition, the product operating information is restored and automatically restarted after main electricity power is reset.

But in emergency operation, automatic re-start is prohibited to protect the product.

Therefore, user must restart the product after power reset when emergency operation has been running.

Control Panel Setting

How to enter installer setting mode

⚠ CAUTION

Installer setting mode is to set the detail function of the control panel.

If the installer setting mode is not set correctly, it could cause problems to the product, user injury or property damage. This must be set by an certificated installer, and any installation or change that is carried out by a non-certificated person should be responsible for the results. In this case, free service cannot be provided.

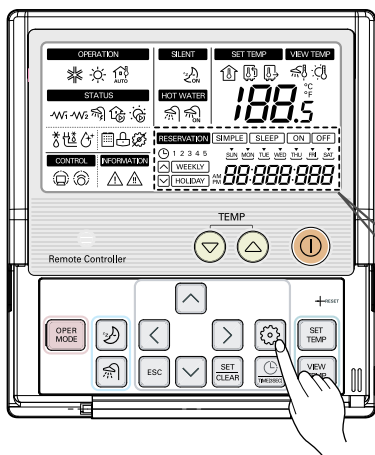

1 Press Function Setting button for 3 seconds to enter the installer setting mode.

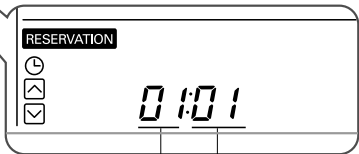

Function Code Value

(When you enter the installer setting mode initially, Function code is displayed on the bottom of the LCD screen.)

Repeat pressing button, and the function code will be changed from 01 to 2A. Please refer the code table on the next page.

Summary

Example of Fuction Code Display

02:00 1: 155

↓ ↓ ↓
 Function Code Value #1 Value #2

Code	Item	Detail	Remark	
1	Function	Test Run	-	
	Description	Instant cooling operation for charging additional refrigerant		
	Value #1	Note		-
		Default		01
		Range		-
	Value #2	Note		-
		Default		-
Range		-		
2	Function	Disable 3 Min. Delay	-	
	Description	Factory use only		
	Value #1	Note		-
		Default		01
		Range		-
	Value #2	Note		-
		Default		-
Range		-		
3	Function	Remote Air Sensor Connection	-	
	Description	Connection information about remote air sensor		
	Value #1	Note		01:Remote air sensor is NOT connected and NOT used 02:Remote air sensor is connected and used
		Default		01
		Range		01-02
	Value #2	Note		-
		Default		-
Range		-		
4	Function	Celsius/Fahrenheit Switching	-	
	Description	Display temperature in Celsius or Fahrenheit		
	Value #1	Note		01:Celsius 02:Fahrenheit
		Default		01
		Range		01-02
	Value #2	Note		-
		Default		-
Range		-		

Code	Item	Detail	Remark	
5	Function	Setting Temperature Selection	-	
	Description	Selection for setting temperature as air temperature or leaving water temperature		
	Value #1	Note		01:Air temperature 02:Leaving water temperature Air temperature as setting temperature is ONLY available when remote air sensor Connection is enabled and Function Code 03 is set as 02.
		Default		02
		Range		01~02
	Value #2	Note		-
		Default		-
Range		-		
6	Function	Auto Dry Contact	-	
	Description	Setting dry contact auto start option. If thermostat is used, value should be changed from "2" to "1"		
	Value #1	Note		01:Auto Start OFF 02:Auto Start ON
		Default		02
		Range		01~02
	Value #2	Note		-
		Default		-
Range		-		
7	Function	Address Setting	-	
	Description	Assigning address when central controller is installed If thermostat is used, value should be changed from "2" to "1"		
	Value #1	Note		-
		Default		00
		Range		00~FF
	Value #2	Note		-
		Default		-
Range		-		
11	Function	Setting Air Temperature in Cooling Mode	'Setting Air Temperature' is used when user wants to set target temperature by room air temperature.	
	Description	Adjusting range of 'Setting Air Temperature' in cooling mode		
	Value #1	Note		Upper Limit of setting range
		Default		30°C
		Range		24~30°C
	Value #2	Note		Lower Limit of setting range
		Default		18°C
Range		18~22°C		
12	Function	Setting Leaving Water Temperature in Cooling Mode	'Setting Leaving Water Temperature' is used when user wants to set target temperature by leaving (from the indoor unit) water temperature.	
	Description	Adjusting range of 'Setting Leaving Water Temperature' in cooling mode		
	Value #1	Note		Upper Limit of setting range
		Default		24°C
		Range		20~25°C
	Value #2	Note		Lower Limit of setting range(FCU is equipped)
		Default		06°C
Range		06~18°C		

Code	Item		Detail		Remark
12	Value #2	Note	Lower Limit of setting range(FCU is NOT equipped)		'Setting Air Temperature' is used when user wants to set target temperature by room air temperature.
		Default	16C		
		Range	16~18C		
13	Function		Setting Air Temperature in Heating Mode		'Setting Leaving Water Temperature' is used when user wants to set target temperature by leaving(from the indoor unit) water temperature. * : Electric heater is not used.
	Description		Adjusting range of 'Setting Air Temperature' in heating mode		
	Value #1	Note	Upper Limit of setting range		
		Default	30C		
		Range	24~30C		
	Value #2	Note	Lower Limit of setting range		
Default		16C			
Range		16~22C			
14	Function		Setting Leaving Water Temperature in Heating Mode		'Setting Sanitary Tank Leaving Water Temperature' is used when user wants to set water temperature of Sanitary Tank.
	Description		Adjusting range of 'Setting Leaving Water Temperature' in heating mode		
	Value #1	Note	Upper Limit of setting range		
		Default	55C		
		Range	35~55C		
	Value #2	Note	Lower Limit of setting range		
Default		15C (* 20C)			
Range		15~34C (* 20~34Ç)			
15	Function		Setting Sanitary Tank Leaving Water Temperature for Sanitary Water Heating		'Setting Electric Heater On/Off temperature' is described in Chapter 8 of Installation Manual.
	Description		Adjusting range of 'Setting Sanitary Tank Leaving Water Temperature' in sanitary water heating mode		
	Value #1	Note	Upper Limit of setting range		
		Default	50C		
		Range	50~80C		
	Value #2	Note	Lower Limit of setting range		
Default		40C			
Range		30~40C			
21	Function		Setting Electric Heater On/Off temperature		DIP Switch setting is described in Chapter 8 of Installation Manual.
	DIP switch setting		No.6 = Off No.7 = On	No.6 = Off No.7 = Off	
	Description		Setting for Using Half capacity of electric heater	Setting for Using Full capacity of electric heater	
	Value #1	Note	Outdoor air temperature where half capacity of electric heater starts operation.	Base outdoor air temperature	
		Default	0 C		
		Range	-15~18C		
	Value #2	Note	Not used	Temperature gap (it means 'how much colder than base outdoor air temperature?')	
		Default	-	0C	
Range		-	0~33C		

Code	Item	Detail	Remark	
22	Function	Setting Cut-off Temperature in Cooling Mode (FCU setting included)	-	
	Description	Determine leaving water temperature when the product is turned off. This function is used for preventing condensation on the floor in cooling mode.		
	Value #1	Note		Cut-off temperature. Value #1 is valid when Value #2 is '01 (that means, FCU is installed)'.
		Default		16°C
		Range		16~25°C
	Value #2	Note		Determines if FCU is installed or not. '01' means 'FCU is NOT installed', and '00' means 'FCU is installed.'
		Default		00
Range		00(Equipped)~01(NOT Equipped)		
23	Function	Setting outdoor temperature range for Weather-dependent operation	-	
	Description	Setting outdoor Max/Min temperature for weather-dependent operation		
	Value #1	Note		Upper Limit of setting range
		Default		-10°C
		Range		-20~05°C
	Value #2	Note		Lower Limit of setting range
		Default		15°C
Range		10~20°C		
24	Function	Setting indoor air temperature range for Weather-dependent operation	-	
	Description	Setting indoor Max/Min temperature for weather-dependent operation		
	Value #1	Note		Upper Limit of setting range
		Default		21°C
		Range		20~30°C
	Value #2	Note		Lower Limit of setting range
		Default		16°C
Range		16~19°C		
25	Function	Setting leaving water temperature range for Weather-dependent operation	-	
	Description	Setting leaving water Max/Min temperature for weather-dependent operation		
	Value #1	Note		Upper Limit of setting range
		Default		55°C
		Range		35~55°C
	Value #2	Note		Lower Limit of setting range
		Default		15°C (* 20°C)
Range		15~34°C (* 20~34°C)		
26	Function	Setting Disinfection Operation	Sanitary water heating should be enable • If sanitary water heating is disable,	
	Description	Setting start/maintain time for disinfection		
	Value #1	Note		Enable/Disable of Disinfection Operation(00:Disable , 01:Enable)
		Default		00
		Range		00~01

* : Electric heater is not used.

Code	Item	Detail	Remark
	Value #1	Note	Starting Date(Sunday:1,Monday:2, ..., Saturday:7)
		Default	06
		Range	01-07
	Value #2	Note	Starting Time in 24 hours(00-23)
		Default	23
		Range	00-23
27	Function		Setting Disinfection Operation
	Description		Setting disinfection temperature
	Value #1	Note	Maximum heating temperature
		Default	70°C
		Range	40~80°C
	Value #2	Note	Maximum heating duration in minute
Default		10min	
Range		05~60min	
28	Function		Setting control parameter for Sanitary water heating operation
	Description		See below notes for each values
	Value #1	Note	Temperature gap from Value #2 of Function Code 28
		Default	05°C
		Range	01~20°C
	Value #2	Note	Maximum temperature generated by AWHP compressor cycle
Default		50°C	
Range		40~50°C	
29	Function		Setting control parameter for Sanitary water heating operation
	Description		See below notes for each values
	Value #1	Note	Temperature gap from target sanitary water temperature. (This value is required to frequent On and Off of water tank heater)
		Default	03°C
		Range	02~04°C
	Value #2	Note	Determining heating demand priority between sanitary water tank heating and under floor heating
Default		00	
Range		00~01	
2A	Function		Miscellaneous setting
	Description		Determine electric heater and water heater on and off
	Value #1	Note	00 : Operate both Electric Heater and Sanitary Tank Heater 01 : Operate ONLY Sanitary Tank Heater
		Default	00
		Range	00~01
	Value #2	Note	Not used
Default		-	
Range		-	

the disinfection mode will not be operated although Value #1 of Code 26 is set as '01'.

- To use disinfection mode, sanitary water heating should be enable.

Only available when Sanitary Water Tank is installed.

Code	Item	Detail	Remark	
2B	Function	Sanitary water heating timers	-	
	Description	Determine following time duration : operation time of sanitary tank heating, stop time of sanitary tank heating, and delay time of sanitary tank heater operating.		
	Value #1	Note		This time duration defines how long time sanitary tank heating can be continued.
		Default		30min
		Range		5 ~ 95 min (step: 5 min)
	Value #2	Note		This time duration defines how long time sanitary tank heating can be stopped. It is also regarded as time gap between sanitary tank heating cycle.
		Default		180 min
		Range		0 ~ 600 min (step: 30 min)
	Value #3	Note		This time duration defines how long time sanitary tank heater will not be turned on in sanitary water heating operation.
		Default		20 min
		Range		20 ~ 95 min (step: 5 min)

* Some contents may not be displayed depending on DIP switch setting in the indoor unit PCB

Common Setting

- **Function Code 01** : Test Run

Test run should be performed when additional refrigerant charging is required. To charge the refrigerant, the product must run in Cooling mode. Test run instantly makes the product working in Cooling mode for 18 minutes.

Note: • If you press any kind of button during this mode, Test Run mode will be finished.

- After running 18 minutes under test run mode, system will automatically turn OFF.

- **Function Code 02** : Disable 3 minute Delay

Factory use only.

- **Function Code 03** : Remote Air Sensor Connection

If user connects remote air sensor to control the product by room air temperature, the connection information should be notified to the product.

Note : If remote air sensor is connected but this function code is not set correctly, the product can not be controlled by room air temperature.

- **Function Code 04** : Celsius/Fahrenheit Switching

Temperature is displayed in Celsius or Fahrenheit.

- **Function Code 05** : Setting Temperature Selection

The product can be operated according to air temperature or leaving water temperature. The selection for setting temperature as air temperature or leaving water temperature is determined.

Note : Air temperature as setting temperature is ONLY available when Remote Air Sensor Connection is enabled and Function Code 03 is set as 02.

- **Function Code 06** : Auto Dry Contact

This function allows the Dry contact-indoor unit operate under Auto Run mode or Manual mode with remote control panel.

If thermostat is used, value should be changed from "2" to "1"

- **Function Code 07** : Address Setting

When Central Controller is installed, address assigning is set by this function.

Temperature Range Setting

- **Function Code 11** : Setting Air Temperature in Cooling Mode
Determine cooling setting temperature range when air temperature is selected as setting temperature.

! NOTICE

Only available when remote air temperature sensor is connected

- Accessory PQRSTA0 should be installed.
- Also, Function Code 03 should be set properly.

- **Function Code 12** : Setting Leaving Water Temperature in Cooling Mode
Determine cooling setting temperature range when leaving water temperature is selected as setting temperature.

! NOTICE

Water condensation on the floor

- While cooling operation, it is very important to keep leaving water temperature higher than 16°C. Otherwise, dew condensation can be occurred on the floor.
- If floor is in humid environment, do not set leaving water temperature below 18 °C.

! NOTICE

Water condensation on the radiator

- While cooling operation, cold water may not flow to the radiator. If cold water enters to the radiator, dew generation on the surface of the radiator can be occurred.

- **Function Code 13** : Setting Air Temperature in Heating Mode
Determine heating setting temperature range when air temperature is selected as setting temperature.

! CAUTION

Only available when remote air temperature sensor is connected

- Accessory PQRSTA0 should be installed.
- Also, Function Code 03 should be set properly.

- **Function Code 14** : Setting Leaving Water Temperature in Heating Mode
Determine heating setting temperature range when leaving water temperature is selected as setting temperature.

- **Function Code 15** : Setting Sanitary Tank Leaving Water Temperature
Determine heating setting temperature range of water tank leaving water.

! NOTICE

Only available when sanitary water tank feature is installed

- Sanitary water tank and sanitary water tank kit should be installed.
- DIP switch No. 2 and 3 should be set properly.

Temperature Control Parameter Setting

• **Function Code 21** : Setting Electric Heater On/Off temperature

Using Half capacity of electric heater : when DIP Switch No. 6 and 7 is set as 'OFF-ON' :

- Value #1 : outdoor air temperature where half capacity of electric heater starts operation.

- Value #2 : not used.

- Example : If Value #1 is set as '-1' and DIP Switch No 6. and 7 is set as 'OFF-ON', then half capacity of electric heater will start operation when outdoor air temperature is below -1°C and current leaving water temperature or room air temperature is much lower than target leaving water temperature or target room air temperature.

Using Full capacity of electric heater : when DIP Switch No. 6 and 7 is set as 'OFF-OFF' :

- Value #1 : base outdoor air temperature.

- Value #2 : temperature gap (it means 'how much colder than base outdoor air temperature?')

- Example : If Value #1 is set as '-1' and Value #2 is set as '3' and DIP Switch No 6. and 7 is set as 'OFF-OFF', then full capacity of electric heater will start operation when outdoor air temperature is below -4°C (-4 = Value #1 - Value #2) and current leaving water temperature or room air temperature is far much lower than target leaving water temperature or target room air temperature.

• **Function Code 22** : Setting Cut-off Temperature in Cooling Mode (FCU setting included)

Determine leaving water temperature when the product is turned off. This function is used for preventing condensation on the floor in cooling mode.

- Value #1 : cut-off temperature. Value #1 is valid when Value #2 is '01' (that means, FCU is installed)'

- Value #2 : determines if FCU is installed or not. '01' means 'FCU is NOT installed', and '00' means 'FCU is installed.'

- Example : If Value #1 is set as '10' and Value #2 is '01' and actually FCU is NOT installed in the water loop, the product stop operation in cooling mode when the leaving water temperature is below 10 °C.

- Example : If Value #1 is set as '10' and Value #2 is '00' and actually FCU is installed in the water loop, the Value #1 is not used and the product do NOT stop operation in cooling mode when the leaving water temperature is below 10 °C.

! NOTICE

FCU Installation

- If FCU is used, related 2way valve should be installed and connected to the indoor unit PCB.
- If Value #2 is set as '00' but FCU or 2way valve is NOT installed, the product can abnormal operation.

Function Code 23 and 24 : Setting Weather-dependent operation Mode

• **Function Code 23, 24, and 25** : Setting Weather-dependent operation

Weather-dependent operation is that the product automatically adjusts target temperature (leaving water or room air) according to the outdoor air temperature.

- Value #1 and Value #2 of Function Code 23 : range of outdoor air temperature
- Value #1 and Value #2 of Function Code 24 : range of auto-adjustable target room air temperature
- Value #1 and Value #2 of Function Code 25 : range of auto-adjustable target leaving water temperature

Note : Weather-dependent operation is applied for heating mode only.

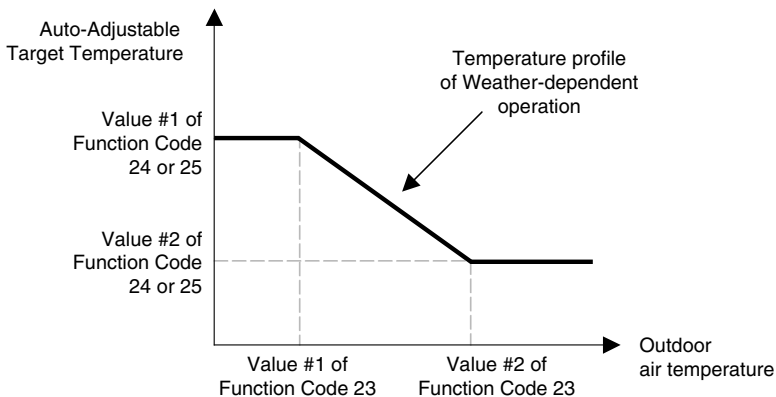

• Function Code 26 and 27 : Setting Disinfection operation

Disinfection operation is special sanitary tank operation mode to kill and to prevent growth of viruses inside the tank.

- Value #1 of Function Code 26 : Selecting enable or disable of disinfection operation. '00' for disable, and '01' for enable.
- Value #2 of Function Code 26 : Determining the date when the disinfection mode is running. '01' for Sunday, '02' for Monday, ... , and '06' for Saturday.
- Value #3 of Function Code 26 : Determining the time when the disinfection mode is running. '00' for 0:00am, '01' for 01:00am, ... , '22' for 10:00pm, and '23' for 11:00pm.
- Sunday, '02' for Monday, ... , and '06' for Saturday.
- Value #1 of Function Code 27 : Target temperature of disinfection mode.
- Value #2 of Function Code 27 : Duration of disinfection mode.

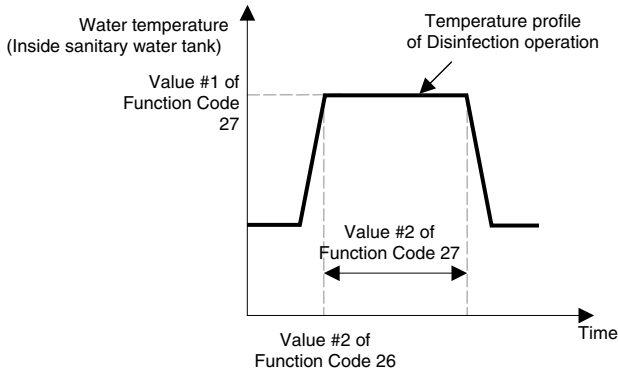

! NOTICE

Vales of Function Code 26

- If Value #1 of Function Code 26 is set as '00', that is 'disable disinfection mode', Value #2 and Value #3 is not used.
- When Value #1 is set as '01', that is 'enable disinfection mode', Value #2 is displayed at the position of Value #1 and Value #3 is displayed at the position of Value #2. It is due to limited width of the control panel display.

! NOTICE

Sanitary water heating should be enable

- If sanitary water heating is disable, the disinfection mode will not be operated although Value #1 of Code 26 is set as '01'.
- To use disinfection mode, sanitary water heating should be enable.(by button input or scheduler programming)

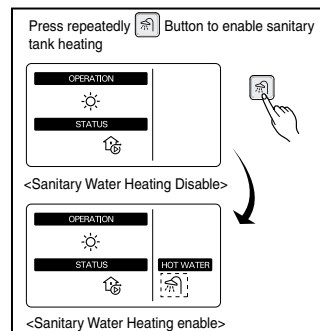

• **Function Code 28 and 29** : Setting control parameter for Sanitary water heating operation

Descriptions for each parameters are as following.

- Value #1 of Function Code 28 : temperature gap from Value #2 of Function Code 28.
- Value #2 of Function Code 28 : maximum temperature generated by AWHP compressor cycle.
- Example : If Value #1 is set as '5' and Value #2 is set as '48', then Session A (see the graph) will be started when the water tank temperature is below 45°C. If temperature is above 48 °C, then Session B will be started.

- Value #1 of Function Code 29 : temperature gap from target sanitary water temperature. This value is required to frequent On and Off of water tank heater.
- Value #2 of Function Code 29 : Determining heating demand priority between sanitary water tank heating and under floor heating.
- Example : If user's target temperature is set as '70' and Value #1 is set as '3', then the water tank heater will be turned off when the water temperature is above 73 °C. The water tank heater will be turned on when the water temperature is below 70 °C.
- Example : If Value #2 is set as '0', that means heating priority is on sanitary water heating, sanitary water is heated by AWHP compressor cycle and water heater. In this case the under floor can not be heated while sanitary water heating. On the other hand, if the Value #2 is set as '1', that means heating priority is on under floor heating, sanitary tank is ONLY heated by water heater. In this case the under floor heating is not stopped while sanitary water is heated.

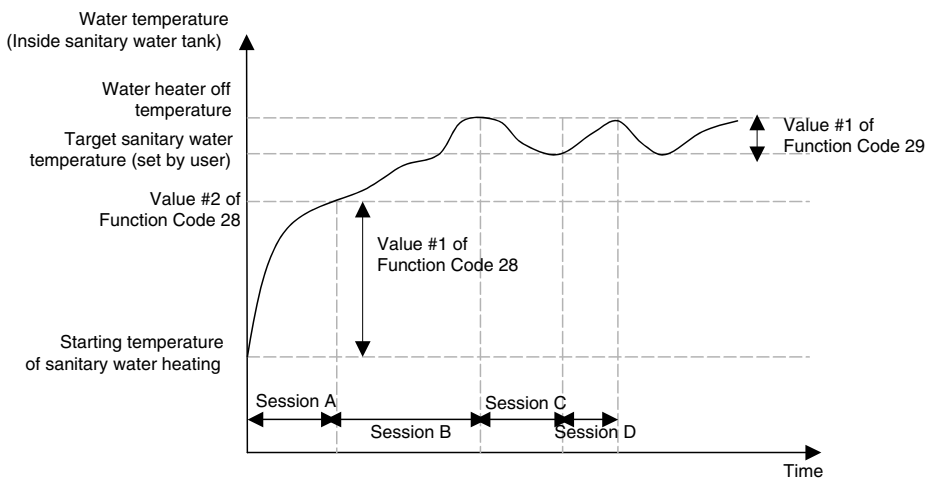

- Session A : Heating by AWHP compressor cycle and water heater
- Session B : Heating by water heater
- Session C : No heating (Water heater is Off)
- Session D : Heating by water heater

! NOTICE

Sanitary water heating does not operate when it is disabled.

Enabling / Disabling of sanitary water heating is determined by pushing  button.

When  icon is displayed on the control panel, sanitary water heating is enabled. (by button input or scheduler programming)

• **Function Code 2A** : Miscellaneous setting

- Value #1 of Function Code 2A : determine electric heater and sanitary tank heater on and off.
- Value #2 of Function Code 2A : not used.
- Example : If Value #1 is set as '0', then electric heater and sanitary tank heater are on and off according to control logic. If Value #1 is set as '1', then electric heater is never turned on and only water heater is on and off according to control logic.

• **Function Code 2B** : Sanitary water heating timers

Determine following time duration : operation time of sanitary tank heating, stop time of sanitary tank heating, and delay time of sanitary tank heater operating.

- Value #1 of Function Code 2B : This time duration defines how long time sanitary tank heating can be continued.
- Value #2 of Function Code 2B : This time duration defines how long time sanitary tank heating can be stopped. It is also regarded as time gap between sanitary tank heating cycle.
- Value #3 of Function Code 2B : This time duration defines how long time sanitary tank heater will not be turned on in sanitary water heating operation.
- Example of timing chart :

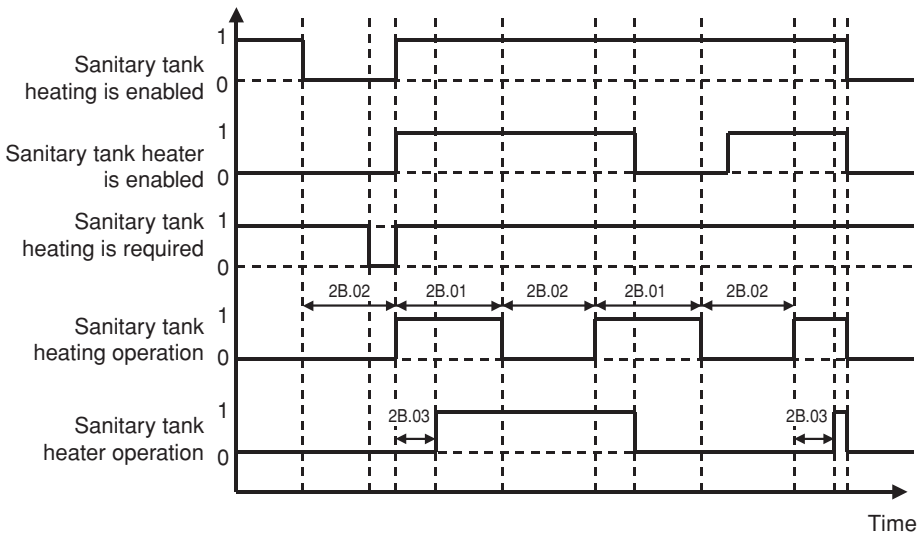

* 1=active / 0=not active

9. Check Points, Maintenance and Troubleshooting

If everything is going well until now, it is time to start the operation and to take advantages of **THERMAV**. Before starting operation, pre-check points are described in this chapter. Some comments about maintenance and how to do troubleshooting are presented.

Check List before Starting Operation

⚠ CAUTION

Turn off the power before changing wiring or handling product

No	Category	Item	Check Point
1	Electricity	Field wiring	<ul style="list-style-type: none"> All switches having contacts for different poles should be wired tightly according to regional or national legislation. Only qualified person can proceed wiring. Wiring and local-supplied electric parts should be complied with European and regional regulations. Wiring should be following the wiring diagram supplied with the product.
2		Protective devices	<ul style="list-style-type: none"> Install ELB (earth leakage breaker) with 30mA. ELB inside the control box of the indoor unit should be turned on before starting operation.
3		Earth wiring	<ul style="list-style-type: none"> Earth should be connected. Do not earth to gas or city water pipe, metallic section of a building, surge absorber, etc.
4		Power supply	<ul style="list-style-type: none"> Use dedicated power line.
5		Terminal block wiring	<ul style="list-style-type: none"> Connections on the terminal block (inside the control box of the indoor unit) should be tightened.
6	Water	Charged water pressure	<ul style="list-style-type: none"> After water charging, the pressure gage (in front of the indoor unit) should indicate 2.0~2.5 bar. Do not exceed 3.0 bar.
7		Air purge	<ul style="list-style-type: none"> During water charging, air should be taken out through the hole of the air purge. If water does not splash out when the tip (at the top of the hole) is pressed, then air purging is not completed yet. If well purged, the water will splash out like fountain. Be careful when testing air purge. Splashed water may make your dress wet.
8		Shut-off valve	<ul style="list-style-type: none"> Two shut-off valves (located at the end of water inlet pipe and water outlet pipe of the indoor unit) should be open.
9		By-pass valve	<ul style="list-style-type: none"> By-pass valve should be installed and adjusted to secure enough water flow rate. If water flow rate is low, flow switch error (CH14) can be occurred.
10	Product Installation	Hang to the wall	<ul style="list-style-type: none"> As the indoor unit is hung on the wall, vibration or noise can be heard if the indoor unit is not fixed tightly. If the indoor unit is not fixed tightly, it can fall down during operation.
11		Parts inspection	<ul style="list-style-type: none"> There should be no apparently damaged parts inside the indoor unit.
12		Refrigerant leakage	<ul style="list-style-type: none"> Refrigerant leakage degrades the performance. If leakage found, contact qualified LG air conditioning installation person.
13		Drainage treatment	<ul style="list-style-type: none"> While cooling operation, condensed dew can drop down to the bottom of the indoor unit. In this case, prepare drainage treatment (for example, vessel to contain condensed dew) to avoid water drop.

Maintenance

To assure best performance of **THERMAV**, it is required to perform periodical check and maintenance. It is recommended to proceed following check list for once a year.

CAUTION

Turn off the power before proceeding maintenance

No	Category	Item	Check Point
1	Water	Water pressure	<ul style="list-style-type: none"> • In normal state, the pressure gage (in front of the indoor unit) should indicate 2.0~2.5 bar. • If the pressure is less than 0.3 bar, please recharge the water.
2		Strainer(Water filter)	<ul style="list-style-type: none"> • Close the shut-off valves and disassemble strainer. Then wash the strainer to make it clean. • While disassembling the strainer, be careful for water flood out.
3		Safety valve	<ul style="list-style-type: none"> • Open the switch of the safety valve and check if water is flood out through the drain hose. • After checking, close the safety valve.
4	Electricity	Terminal block wiring	<ul style="list-style-type: none"> • Look and inspect if there is loosen or defected connection on the terminal block.



Troubleshooting

If **THERMAV** operates not properly or it does not start operation, please check following list.

CAUTION

Turn off the power before proceeding troubleshooting

Troubleshooting for Problem while Operation

No	Problem	Reason	Solution
1	Heating or cooling is not satisfactory.	• Setting target temperature is not proper.	• Set target temperature correctly. • Check if temperature is water-based or air-based. See Function code 03 and 05.
		• Charged water is not enough.	• Check pressure gage and charge more water until pressure gage is indicating 2.0~2.5 bar.
		• Water flow rate is low.	• Check if strainer gathers too much particles. If so, strainer should be cleaned. • Check if internal water pump speed is NOT set as 'High'. It should be set as 'High.' • Check if pressure gage indicates above 0.3 bar. • Check if water pipe is getting closed due to stacked particles or lime.
2	Although electric power supply is OK (control panel displays information), the outdoor unit does not start working.	• Water inlet temperature is too high.	• If water inlet temperature is above 55°C, the outdoor unit does not operated for the sake of system protection.
		• Water inlet temperature is too low.	• If water inlet temperature is below 5°C, the outdoor unit does not operated for the sake of system protection. Wait while indoor unit warms up the water inlet temperature.
3	Water pump noise.	• Air purging is not completely finished.	• Open the cap of air purge and charge more water until pressure gage is indicating 2.0~2.5 bar. • If water does not splash out when the tip (at the top of the hole) is pressed, then air purging is not completed yet. If well purged, the water will splash out like fountain.
		• Water pressure is low.	• Check if pressure gage indicates above 0.3 bar. • Check if the expansion tank and pressure gage operates well.
4	Water is flood out through drain hose.	• Too much water is charged.	• Flood out the water by opening the switch of the safety valve until pressure gage is indicating 2.0~2.5 bar.
		• Expansion tank is damaged.	• Replace the expansion tank.
5	Sanitary water is not hot.	• Thermal protector of water tank heater is activated.	• Open the side panel of the sanitary water tank and push the reset button of the thermal protector. (for more detail information, please refer to installation manual of sanitary water tank.)
		• Sanitary water heating is disabled.	• Push  button and identify if  icon is displayed on the control panel.

Troubleshooting for Problem while Operation

Code No.	Description	Cause	Normal Condition
01	Problem in Remote Room Air sensor	<ul style="list-style-type: none"> • Incorrect connection between sensor and PCB • PCB fault • Sensor fault 	<ul style="list-style-type: none"> • Resistance: 10k ohm at 25 centigrade (unplugged) → for Remote Room Air sensor • Resistance: 5k ohm at 25 centigrade (unplugged) → for all sensors EXCEPT Remote Room Air sensor • Voltage: 2.5Vdc at 25 centigrade (plugged) (for all sensors) • Refer resistance-temperature table to check in different temperature
02	Problem in Refrigerant (Inlet side) sensor		
06	Problem in Refrigerant (Outlet side) sensor		
08	Problem in Water Tank sensor		
13	Problem in Solar-thermal sensor		
16	Problems in sensors		
17	Problem in Water-inlet sensor		
18	Problem in Water-outlet sensor	<ul style="list-style-type: none"> • Wire connection between control panel and indoor unit PCB should be tight • Output voltage of PCB should be 12Vdc 	
19	Problem in Water-interlim sensor		
03	Bad communication between control panel and indoor uni	<ul style="list-style-type: none"> • Incorrect connection between sensor and PCB • PCB fault • Sensor fault 	<ul style="list-style-type: none"> • Wire connection between control panel and indoor unit PCB should be tight
05	Bad communication between Indoor unit and Outdoor unit	<ul style="list-style-type: none"> • The connector for transmission is disconnected • The connecting wires are misconnected • The communication line is broken 	
53		<ul style="list-style-type: none"> • Outdoor PCB is abnormal • Indoor PCB is abnormal 	
09	PCB Program (EEPROM) Fault	<ul style="list-style-type: none"> • Electrical or mechanical damage a the EEPROM 	<ul style="list-style-type: none"> • This error can not be permitted
14	Problem in Flow Switch	<ul style="list-style-type: none"> • Flow switch is open while internal water pump is working • Flow switch is closed while internal water pump is not working • Flow switch is open while DIP switch No. 5 of indoor unit PCB is set as ON 	<ul style="list-style-type: none"> • Flow switch should be closed while internal water pump is working or DIP switch No. 5 of indoor unit PCB is set as ON • Flow switch should be open while internal water pump is not working
15	Water pipe overheated	<ul style="list-style-type: none"> • Abnormal operation of electric heater • Leaving water temperature is above 72°C 	<ul style="list-style-type: none"> • If there is no problem in electric heater control, possible maximum leaving water temperature is 62°C.
20	Thermal fuse is damaged	<ul style="list-style-type: none"> • Thermal fuse is cut off by abnormal overheating of internal electric heater • Mechanical fault at the rmal fuse • Wire is damaged 	<ul style="list-style-type: none"> • This error will not be happened if temperature of electric heater tank is below 90°C.
44	Problem in outdoor temperature sensor.	<ul style="list-style-type: none"> • Incorrect connection between sensor and PCB • PCB fault • Sensor fault • Outdoor temperature is below -25°C. 	<ul style="list-style-type: none"> • Sensor connection and PCB & sensor fault should be checked. • This error will not be happened if outdoor temperature is above -25°C.

